

RAIN ***BIRD***®

Low-Volume Landscape Irrigation Design Manual



RAIN BIRD®

Low-Volume Landscape Irrigation Design Manual



***Xerigation®: Maximizing the effective use
of every drop of water***

© Copyright Rain Bird Sales, Inc., Landscape Drip Division 2000

Information contained in this manual is based upon generally accepted formulas, computation and trade practices. If any problems, difficulties or injuries should arise from or in connection with the use or application of this information or if there is any error herein, typographical or otherwise, Rain Bird Sales, Inc. and its subsidiaries and affiliates or any agent or employee thereof, shall not be responsible or liable therefor.



FOREWORD

Over the past four years, “Xerigation® Product, Design and Installation” seminars have been conducted across the U.S., in Mexico, Canada and even Europe. Rain Bird has talked to more than 1,000 irrigation professionals about landscape low-volume irrigation. In the past, the most frequently asked question was, “Why should I use low-volume irrigation?” Today, however, most seminar attendees share the basic understanding that, when properly used, landscape low-volume irrigation products can save significant amounts of water. These products can also help keep water off walls, windows, sidewalks and streets. At the same time, the use of these products promotes healthier plant growth because water is delivered more slowly and at lower pressures at or near plant root zones.

Now, the most frequently asked questions are, “What is the proper way to do drip design?” “How do you decide when and where to use drip products?” “How can the maintenance factor associated with drip be significantly reduced or eliminated?” These kinds of questions indicate a growing acceptance of low-volume irrigation within the industry, a trend that is helping landscape drip irrigation equipment become fundamental to good water management practice.

This design manual is intended to provide straightforward answers to these questions. It is our hope that the reader will realize the benefits of landscape low-volume irrigation by utilizing the design approach explained in this manual. It is an approach that has proven itself in practice over the past several years.

This manual continues to take the same cutting-edge approach to low-volume irrigation by considering plant root depths and water loss due to percolation below the root zone to be essential design parameters.

In this manual, we will introduce the Xerigation product line and discuss the benefits of its use. We will then discuss the design approach for a low-volume delivery system and follow up with practical recommendations for installation, ongoing maintenance and troubleshooting.

For more information on the Xerigation product line or Rain Bird’s broad line of irrigation products, contact your local Rain Bird Distributor, Rain Bird Representative, or call our Technical Services Group at 1-800-247-3782. Or, visit our website at www.rainbird.com.

The reader should realize that it is not possible in a single publication to cover all conceivable drip design situations that may arise. As such, it is not the intent of this design manual to provide all the answers. Rather, this manual is intended to help the user understand the fundamentals of low-volume irrigation and to provide a foundation for a successful experience with drip.

CONTENTS

1

What is Xerigation®? 1

- Low-volume Irrigation 1
- Benefits of Low-Volume Irrigation 2
- Selecting Low-Volume Irrigation 4
 - Installation Cost 4
 - Size of Area 4
 - Vandalism 4
 - Safety 4
 - Intended Use 4
- Xerigation Product Line 4

2

The Design Process 5

- An Innovative Approach 5
- The Xerigation Design Process 6
- Individual Plants Versus Dense Plantings 7

3

Gather Site Data 9

- Site Information 10
- Water source 10
- Soil Type 11
- Climate and PET 13
- Hydrozones 14
- Chapter 3 Review 15
 - Sample Property 15
 - Site Data Worksheet 17
 - Answer Key 18

4

Determine Plant Water Requirements 19

- Calculating Water Requirements 21
 - Site Information 21
 - Calculate K_c 21
 - Water Requirement for Densely Planted Areas 24
 - Water Requirement for Individual Plants 24
- Chapter 4 Review 26
 - Answer Key 27

5

Irrigate Base Plants 29

- Identifying the Base Plant 29
 - Dense Plantings 29
 - Sparse Plantings 29
- Emission Devices 30
 - Xerigation Products Application Matrix 32
 - Dense Plantings 32
 - Landscape Dripline 32
 - Xeri-Sprays 38
 - Xeri-Pop Series Micro-Spray Pop-Ups 38
 - Multi-Port Spray Nozzle 38

	Sparse Plantings	38
	Selecting Emitters	39
	Calculating the Wetted Area	40
	Chapter Review	41
	Answer Key	42
6	Calculate System Run Time	43
	1. Calculate System Run Time	44
	Dense Plantings	44
	Sparse Planting	45
	2. Determine Maximum Run Time	46
	3. Determine Irrigation Interval	48
	Chapter Review	49
	Answer Key	50
7	Irrigate Non-Base Plants	51
	Chapter Review	52
	Answer Key	53
	Dense Hydrozone Design Worksheet	54
8	System Layout	55
	Using Inline Tubing	57
	Placing Supplemental Emitters	57
	System Configuration	59
	Irrigating Slopes	61
	Container Plants	62
9	System Hydraulics	63
	Water Pressure	63
	Static/Dynamic Pressure	63
	Calculating Pressure Loss	64
	Flow	64
	Determine Maximum Lateral Lengths	68
	Pressure Loss Calculation	69
	High Pressure	71
	Hydraulics Worksheet	72
10	Installation, Maintenance, and Trouble Shooting	73
	Installation	73
	Maintenance and Troubleshooting	74
	Appendices	77
	Formulas For Xerigation Design	77
	PET Data	81
	Friction Loss and Performance Data	85
	Xerigation Planning Blank Forms	87
	Glossary	95
	Xerigation Product Line	99
	Installation Details	103
	Bibliography	104
	Index	105



1

WHAT IS XERIGATION®?

Xerigation is Rain Bird's registered trademark term for a system that distributes water directly to plant root zones using Rain Bird's low-volume, landscape-specific irrigation products. "Xerigation" is closely related to the word Xeriscape™, which refers to a landscape that conserves water by following the "Seven Principles of Xeriscape Landscaping." These principles are:

1. Proper planning and design.
2. Soil analysis and improvement.
3. Practical turf areas.
4. Appropriate plant selection.
5. Efficient irrigation.
6. Mulching.
7. Appropriate maintenance.

It is in the interest of efficient irrigation that Rain Bird developed the Xerigation product line to meet the evolving needs of today's landscapes by maximizing the effective use of every drop of water.

Low-Volume Irrigation

Low-volume irrigation is simply a method of distributing water to plants. Like conventional overhead systems, a low-volume system requires proper design, installation, and ongoing maintenance. Table 1-1 highlights some of the similarities and differences between conventional and low-volume irrigation systems.



TABLE 1-1: CONVENTIONAL VS. LOW-VOLUME IRRIGATION		
	Conventional Irrigation (Spray Heads and Rotors)	Low-Volume Irrigation (Xerigation)
Design	Design goal is to broadcast water as evenly as possible across an entire area. Water is delivered to the surface of the planted area.	Design goal is to apply water to a uniform depth, either directly to the plant root zone or in a limited area. Water is delivered at or below the surface of the planted area.
Installation	Most of system installed in underground trenches.	In residential applications, most of system installed at or near grade and covered with 2-3 inches of mulch. Typically, installation requires less time. In commercial applications, most of system installed in underground trench and exposure of any drip tubing is minimal.
Maintenance	Problems with system are easy to spot. Many problems require trenching to repair. Solvents are required to repair pipes.	Problems with system may be less noticeable. Scheduled maintenance requires greater attention. However, most problems with the system can be repaired faster and more easily than conventional systems. Generally, no solvents are used.

Benefits of Low-Volume Irrigation

Better Water Management

The most important benefit of low-volume irrigation is its potential to reduce or eliminate water waste. Using low-volume irrigation, you can match the water application to the specific needs of each plant. You can also match the water application rate to the soil's infiltration rate more closely, and you can apply water directly to the plant root zones to virtually eliminate evaporation. Since water is directed exactly where you need it, very little water is wasted on the areas between widely spaced plants.

Lower Maintenance Costs

A conventional sprinkler system can spray water onto windows, erode paving, wash away paint and plaster, and rot wood. A low-volume irrigation system keeps water off windows, streets, walls and fences, which helps reduce the maintenance costs associated with replastering, repaving, repainting and rebuilding.

Improved Plant Health

Low-volume irrigation can improve plant health. Figure 1-1 shows that the most active part of a plant's root zone is the top half, which absorbs up to 70 percent of the plant's water and nutrient intake. You will generally design your system to deliver 70 percent of the water to the upper half of the root zone and 30 percent to the lower root zone to encourage deep root development.

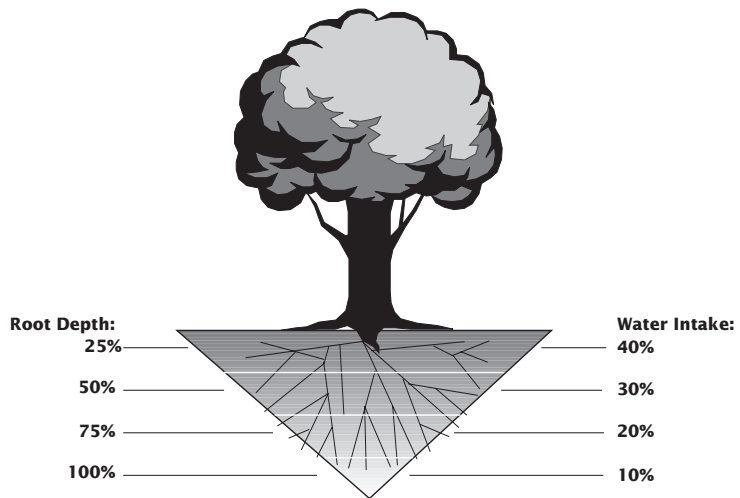

Figure 1-1: Soil moisture extraction by plant root zone

Figure 1-2 shows that in conventional irrigation, plants often alternate between receiving more water than they need and being too dry. With properly managed low-volume irrigation, the optimum moisture level can be better maintained. Also, disease control is improved, plants can tolerate higher salinity levels in the irrigation water, and more uniform application of water to the plant material is achieved.

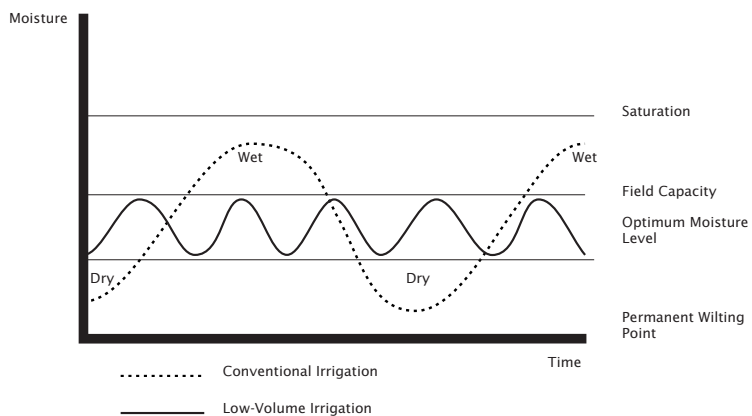

Figure 1-2: Wet/dry cycles in conventional and low-volume irrigation

In summary, properly managed low-volume irrigation uses less water, costs less to operate, reduces maintenance costs, enhances plant health and advances good water management practice. And, low-volume irrigation allows the landscape to survive even in the face of severe water shortages and rationing. We all benefit from efficient use of our precious natural resources.



Selecting Low-Volume Irrigation

A Xerigation design is appropriate in any nongrass planting scheme where low-volume irrigation can reduce water usage and improve plant health. Some of the factors that might affect your decision include installation cost, size of the area being irrigated, protection from vandalism, human safety and the type of maintenance that will be provided.

- Installation Cost** In most cases, the cost of materials will be similar for low-volume and conventional irrigation systems. The cost of labor, however, is often less for a low-volume system. Because you can often install low-volume systems at or near grade, you will usually need less trenching and therefore less time and labor.
- Size of Area** Generally, nongrass planting areas of any size can use low-volume irrigation. There are, however, two considerations: plant density and maintenance. A large, densely planted area with a homogeneous plant material, for example, requires uniform watering over a fairly consistent root depth and is therefore better irrigated with broadcast methods. Also, a large area may be easier to maintain if irrigated with a conventional system, which has fewer parts.
- Vandalism** In areas where vandalism can be a problem, it is important to design a system that can be installed below grade as much as possible, with exposed components placed out of sight. Consider the individual circumstances of the site when deciding between low-volume and conventional approaches.
- Safety** Low-volume systems provide greater safety by reducing run-off on walks and paved areas, and overthrow into the street or pedestrian right-of-way.
- Intended Use** Low-volume irrigation may be less appropriate for sites with heavy traffic because the exposed tubing can be damaged. Frequent soil cultivation may also damage low-volume tubing. In these cases, a low-volume system may still be appropriate if you install it below ground using conventional PVC piping (or high-density polyethylene tubing in colder climates) and drip components installed on 1/2" threaded risers. Although the cost of installing low-volume systems below grade may be higher, the long-term benefits of this type of irrigation make it a very worthwhile alternative. This is, in fact, how most commercial drip systems are designed and installed today.

Xerigation Product Line

Rain Bird's Xerigation product line offers a full range of low-volume irrigation products for many landscape applications. These products include a variety of emission devices, distribution components, valves, filters, pressure regulators and risers.

Illustrations and capsule descriptions of many of these Rain Bird Xerigation products are included in the appendix of this manual. For complete information about the Xerigation product line, see the Xerigation section of Rain Bird's *Landscape Irrigation Products Catalog*. To obtain a copy of this catalog, contact the Rain Bird Technical Services Group at 1-800-247-3782. Or, visit the Rain Bird website at www.rainbird.com, where you can review Rain Bird's online catalog and download construction/installation details, written specifications and technical information.

2

THE DESIGN PROCESS

An Innovative Approach

Overhead, broadcast methods of irrigation are ideal for turfgrass, which requires a uniform precipitation rate over its entire planted area. However, the use of overhead irrigation in sparsely planted, nongrass areas causes water to fall on unplanted ground and is wasted, or worse yet, promotes weed growth. A conventional overhead system also is not the best approach for a mixed planting where some specimens need more water than others. Such a system lacks the flexibility of a drip system to deliver different amounts of water to different plants in the same planting area. Even many low-volume design approaches fail to truly optimize the application of water, when water waste below the plant root zone is ignored or not considered.

This manual describes a design process that minimizes water waste below the root zone and that strives to apply the precise amount of water required by each individual plant or group of plants in a landscape. This design process is based on actual cutting-edge research in the field of low-volume irrigation. Landscape and irrigation designers can use this information to design systems based not only on the size of a planted area, but on a plant's root depth, soil type, water requirement and density of planting for the greatest efficiency possible.



The Xerigation Design Process

Table 2-1 lists the major steps in the Xerigation design process described in this manual, along with a brief overview of each step.

TABLE 2-1: XERIGATION DESIGN PROCESS		
Chapter 3	Gather accurate site data	Collect information about the site to be irrigated and the plants in the site.
Chapter 4	Determine plant water requirements	Calculate the precise amount of water required by each plant or area of dense plantings.
Chapter 5	Irrigate "base" plants (i.e.: the plants that use the least amount of water)	Determine the flow, type and quantity of emission devices required for the base plant.
Chapter 6	Calculate system run time	Calculate the run time based on the water needs of the base plant.
Chapter 7	Irrigate "non-base" plants (i.e.: all plants that are not base plants)	Using the daily watering requirement of the non-base plants and the run time previously calculated for the base plants, determine the flow, type and quantity of emission devices required for the non-base plants.
Chapter 8	Lay out the system	Place all emission devices, piping and control zone components.
Chapter 9	Calculate system hydraulics	Determine total system flow and calculate pressure loss through the system.

Individual Plants Versus Dense Plantings

Throughout this manual, we will be drawing a distinction between sparse planting schemes (individual plants) and densely planted areas. For our purposes, dense plantings are those where the space between the plants' mature canopies is less than two feet or where there is some type of ground cover. Figure 2-1 shows a typical sparse planting, while Figure 2-2 shows a typical dense planting.

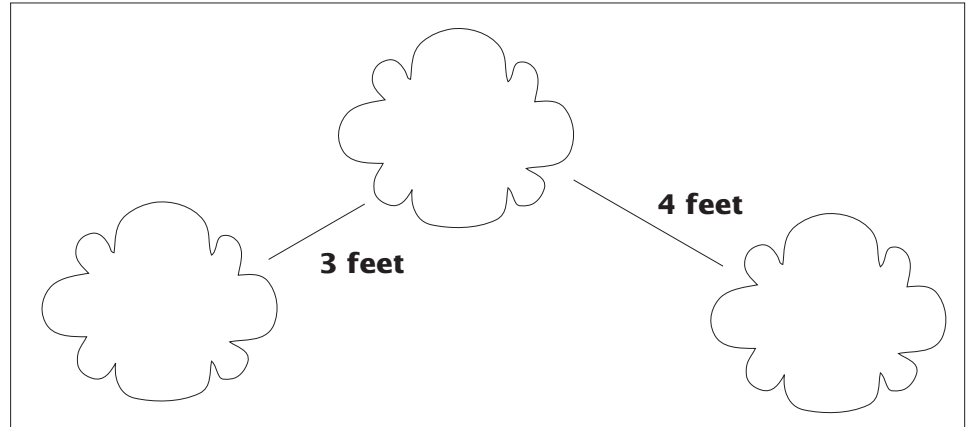

Figure 2-1: Typical sparse planting

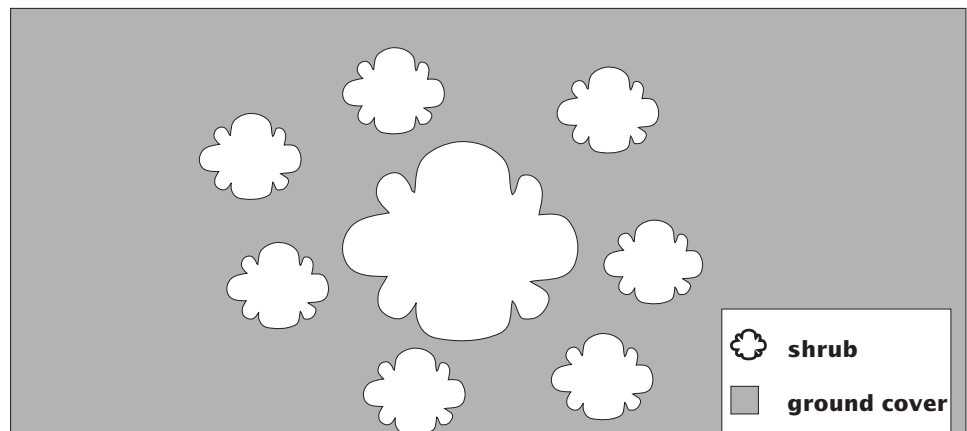

Figure 2-2: Typical dense planting

As you will see later in this manual, this distinction between sparse and dense planting schemes is important because the planting scheme strongly suggests which type of low-volume irrigation system design approach to take and which drip products to use.

- **Individual plants** are generally irrigated by individual emission devices that supply a precise amount of water directly to the plant's root zone (see Figure 2-3). These devices include single- and multi-outlet emitters, as well as micro-bubblers.
- **Dense plantings** require emission devices that supply a precise amount of water across the entire area. These devices include inline emitter tubing (shown in Figure 2-4) and micro-sprays.

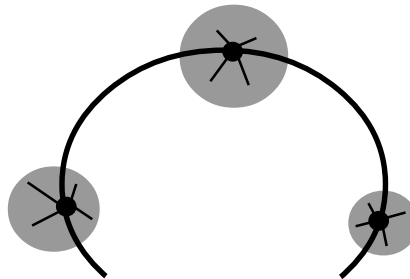

Figure 2-3: Sparse planting irrigated with multi-outlet emitters

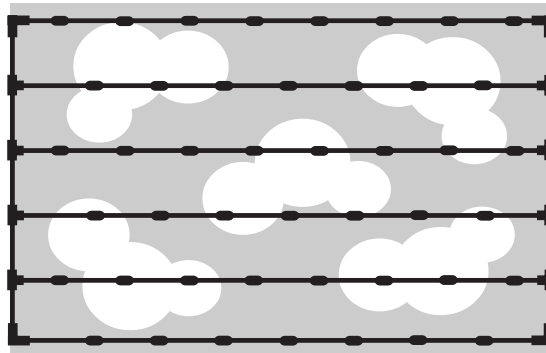

Figure 2-4: Dense planting irrigated with inline emitter tubing

3

GATHER SITE DATA

Accurate site data is important to any irrigation design, but with a low-volume approach it is even more critical because the water is distributed in smaller amounts. Your final design can only be as good as the site data you collect.

Use the Site Data Worksheet (Figure 3-1) below to help you collect and organize site data. A full-size, reproducible blank worksheet is included in Appendix D of this manual.

SITE DATA WORKSHEET			DATE JOB NUMBER																																												
<p>1 Site Information</p> <p>Name _____</p> <p>Address _____</p> <p>City _____ State _____ Zip _____</p> <p>Contact _____</p> <p>Day Phone _____ Eve. Phone _____</p> <p>Pipe Requirements _____</p> <p>Specs on File <input type="checkbox"/> Yes <input type="checkbox"/> No</p> <p>Permits required? <input type="checkbox"/> Yes <input type="checkbox"/> No</p> <p>Cost _____</p>	<p>2 Water Source</p> <p><input type="checkbox"/> City Water</p> <p><input type="checkbox"/> Well:</p> <p style="margin-left: 20px;"><input type="checkbox"/> Sub <input type="checkbox"/> Centrifugal HP _____ PSI _____ GPM _____</p> <p><input type="checkbox"/> Surface Water</p> <p><input type="checkbox"/> Effluent</p> <p style="margin-left: 20px;">Water Quality: <input type="checkbox"/> Good <input type="checkbox"/> Fair <input type="checkbox"/> Poor</p> <p style="margin-left: 20px;">Water Purveyor _____</p> <p style="margin-left: 20px;">Contact _____</p> <p style="margin-left: 20px;">Phone _____</p> <p style="margin-left: 20px;">Meter Location _____</p> <p style="margin-left: 20px;">Meter size (inches) _____</p> <p style="margin-left: 20px;">Service Line Type and Size _____</p> <p style="margin-left: 20px;">Static Pressure (PSI at meter) _____</p> <p style="margin-left: 20px;">Elevation change (± feet) _____</p>	<p>Notes</p> <p>_____</p> <p>_____</p> <p>_____</p> <p>_____</p> <p>_____</p> <p>_____</p> <p>_____</p> <p>_____</p> <p>_____</p> <p>_____</p> <p>_____</p>																																													
<p>3 Soil Type</p> <p><input type="checkbox"/> Coarse</p> <p><input type="checkbox"/> Medium</p> <p><input type="checkbox"/> Fine</p>	<p>4 Climate and PET</p> <p><input type="checkbox"/> Cool Humid <input type="checkbox"/> Cool Dry</p> <p><input type="checkbox"/> Warm Humid <input type="checkbox"/> Warm Dry</p> <p><input type="checkbox"/> Hot Humid <input type="checkbox"/> Hot Dry</p> <p style="margin-left: 20px;">Worst case daily PET (in. per day): _____</p> <p style="margin-left: 20px;">Application Efficiency (%): _____</p>	<p>5 Hydrozones (Attach sketch of property)</p> <table border="1" style="width: 100%; border-collapse: collapse; text-align: center;"> <thead> <tr style="background-color: #333; color: white;"> <th style="width: 5%;">#</th> <th style="width: 45%;">DESCRIPTION</th> <th style="width: 20%;">DENSITY</th> <th style="width: 30%;">IRRIGATION METHOD</th> </tr> </thead> <tbody> <tr><td> </td><td> </td><td> </td><td> </td></tr> <tr><td> </td><td> </td><td> </td><td> </td></tr> <tr><td> </td><td> </td><td> </td><td> </td></tr> <tr><td> </td><td> </td><td> </td><td> </td></tr> <tr><td> </td><td> </td><td> </td><td> </td></tr> <tr><td> </td><td> </td><td> </td><td> </td></tr> <tr><td> </td><td> </td><td> </td><td> </td></tr> <tr><td> </td><td> </td><td> </td><td> </td></tr> <tr><td> </td><td> </td><td> </td><td> </td></tr> <tr><td> </td><td> </td><td> </td><td> </td></tr> </tbody> </table>		#	DESCRIPTION	DENSITY	IRRIGATION METHOD																																								
#	DESCRIPTION	DENSITY	IRRIGATION METHOD																																												

Figure 3-1: Site Data Worksheet

The following descriptions are keyed to the numbers that appear on the Site Data Worksheet. As you read these descriptions, refer to the sample completed worksheet at the end of this chapter.



1 Site Information This section of the form is for identifying the site, recording information about the owner and making notes about local requirements for permits and system specifications.

2 Water Source In this section of the worksheet, check off the type of water source (city water, well, surface water, or effluent). If a pump is used, indicate the type and its specifications. For all water sources, indicate the quality of the water based on the amount of particulate matter present. Fill in the meter size, location, and static water pressure (measured at the meter). Then fill in the information about the service line.

“Dirty” water can be a problem for low-volume systems because of the components’ small orifices. Plan to include filters in your low-volume system to screen out particulates from the water before they become a problem. Table 3-1 shows minimum filtration required for most emitters.

If your water is dirty or contains organic contaminants, consider installing a sand media filter in your system. Hard water may need to be chemically treated to prevent mineral buildup that could clog emitters. If clogging is a concern, instead of emitters use Xeri-Bubblers, which have larger orifices and can be easily taken apart and cleaned. Contact your Rain Bird distributor for more information about specific filtration requirements.

On commercial systems using water that does not contain organic contaminants, it is cost-effective to install a Rain Bird Automatic Filter Kit near the point of connection (see Figure 8-7, Chapter 8). The 150 PSI rated kit is available in 1", 1-1/2" and 2" sizes and consists of a Y-Filter, a Rain Bird PESB scrubber valve, which acts as an automatic flush valve, and fittings. Various screen sizes from 30 to 200 mesh are available to meet the needs of a variety of applications. When the “scrubber” valve is connected to a multi-program irrigation controller such as the Rain Bird ESP-LX+ or ESP-MC, a flush cycle can be programmed to virtually eliminate the need to routinely clean the filter manually.

It is always best to include the appropriate filter in your drip system design, even when using potable water.

TABLE 3-1: MINIMUM FILTRATION REQUIREMENTS		
0.5 GPH	1.0 GPH and larger	Landscape Dripline 0.6 and 0.9 GPH
200 mesh 75 microns	150 mesh 100 microns	120 mesh 125 microns

In many cases, you can call your local water purveyor for information about the water source. The water purveyor should be able to tell you the meter size (if there is one) and the cost of water. The water purveyor may also provide a water-quality report and help you understand it. However, measurements of static pressure and water quality should be performed on-site whenever possible.

③ **Soil Type** Soil absorbs and holds water in much the same way as a sponge. A given type and volume of soil will hold a given amount of moisture. The ability of soil to hold moisture, and the amount of moisture it can hold, will greatly affect the irrigation design and irrigation schedule.

Soil consists of sand, silt and clay particles and the percentage of each is what determines the soil type. Because the percentage of any one of the three particles can differ, there is virtually an unlimited number of soil types.

The simplest way to determine the soil type is to place a moistened soil sample in your hand and squeeze. Take the sample from a representative part of the site and from approximately the same depth to which you will be watering. In other words, if you want to water to a depth of six inches, dig down six inches to take your soil sample. Table 3-2 lists the general characteristics of the three main soil types.

TABLE 3-2: DETERMINING THE SOIL TYPE	
SOIL TYPE	CHARACTERISTICS
Coarse	Soil particles are loose. Squeezed in the hand when dry, it falls apart when pressure is released. Squeezed when moist, it will form a cast, but will crumble easily when touched.
Medium	Has a moderate amount of fine grains of sand and very little clay. When dry, it can be readily broken. Squeezed when wet, it will form a cast that can be easily handled.
Fine	When dry, may form hard lumps or clods. When wet, the soil is quite plastic and flexible. When squeezed between the thumb and forefinger the soil will form a ribbon that will not crack.

One of the most significant differences between different soil types is the way in which they absorb and hold water. Capillary action is the primary force in spreading water horizontally through soil. Vertical movement of water in the soil is influenced by both gravity and capillary action.

An inline emitter tubing system such as Landscape Dripline relies on the soil to evenly spread water throughout the planting area. The more homogeneous the soil in the planting area, the more uniform the water distribution. Therefore, compacted soil must be tilled to an 8" to 12" (20 - 30 cm) depth and should be irrigated to field capacity prior to planting. In coarser soils, water is more likely to be absorbed vertically, but will not spread very far horizontally. The opposite is true for fine, clay-like soil.

Note: Emitters should be used very carefully in very coarse soils as water will percolate downward before it can spread very far horizontally. Micro-sprays or conventional irrigation may be more appropriate.

Figure 3-2 shows the availability of water in soil for use by plants. Moisture held in soil is classified in three categories:

- **Hygroscopic water** is water that is held too tightly in the soil to be used by plants.
- **Capillary water** is water that is held in the pore spaces of the soil and can be used by plants.
- **Gravitational water** drains rapidly from the soil and so is not readily available to be used by plants.

The **Permanent Wilting Point** represents the boundary between **capillary water** (water that is available for plant use) and **hygroscopic water** (water that is unavailable to plants because it is held so tightly by the soil). Since hygroscopic water is not usable by plants, continuous soil moisture levels below the **Permanent Wilting Point** will result in the death of the plants.

Field Capacity represents the boundary between **gravitational water** (water not readily available to plants) and **capillary water**. It is the upper limit for soil moisture that is usable by plants.

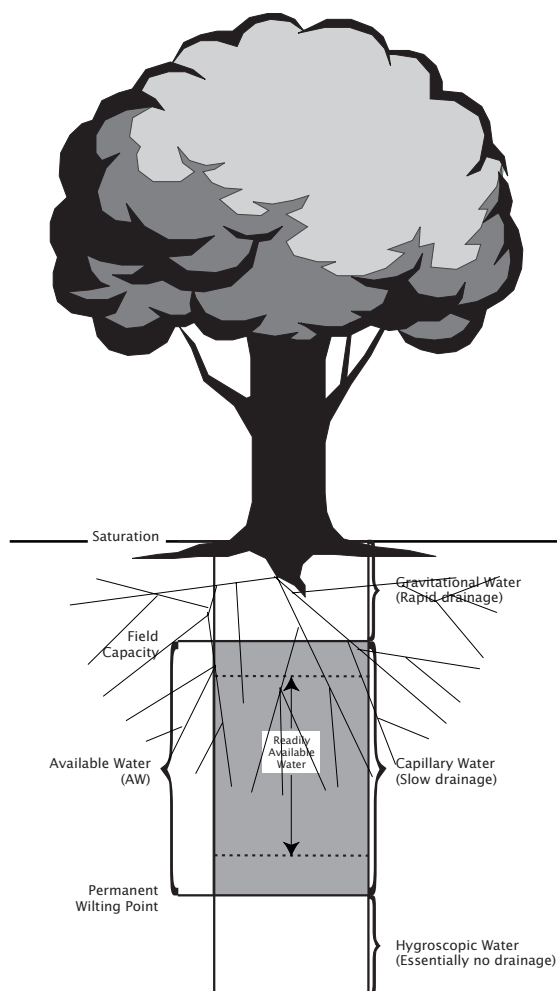
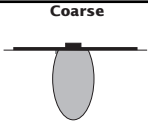
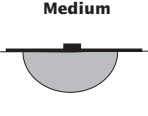
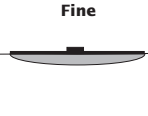

Figure 3-2: Soil, water, plant relationships

Table 3-3 shows the way water is absorbed in the three different soil types:

- Maximum infiltration rate indicates how fast water can be absorbed into the soil without runoff.
- Wetting patterns show the relationship between vertical and horizontal movement of water in the soil up to the maximum wetted diameter. Once the maximum wetted diameter is reached, water movement is downward, forming the traditional “carrot,” “onion,” and “radish” profiles.
- Maximum wetted diameter is the greatest distance water will spread horizontally from an emitter.
- Available Water (AW) is the amount of water that is readily available for use by plants.

TABLE 3-3: SOIL INFILTRATION AND WETTING PATTERN				
Soil Type	Maximum Infiltration Rate	Wetting Pattern	Maximum Wetted Diameter	Available Water (AW)
Coarse (sandy loam)	.72 - 1.25 inches per hour	<p>Coarse</p> 	1.0 - 3.0 feet	1.4 inches per foot
Medium (loam)	.25 - .75 inches per hour	<p>Medium</p> 	2.0 - 4.0 feet	2.0 inches per foot
Fine (clay loam)	.13 - .25 inches per hour	<p>Fine</p> 	3.0 - 6.0 feet	2.5 inches per foot

4 Climate and PET Evapotranspiration (ET) is the amount of water passed off as vapor to the atmosphere from the soil (evaporation) and from plant leaves (transpiration). Potential evapotranspiration (PET) is the maximum average water requirement for plants in a given climate. PET is generally expressed in inches per day. Your system must be designed to satisfy the worst case PET for your area.

On your worksheet, enter information on the general climate of the site, and PET rates in the area to determine the proper system run time.

In many areas, local newspapers publish PET data. This reference PET is generally based on the PET rate for a specific variety of grass under the most favorable soil moisture conditions (field capacity). For areas where specific data is not readily available, Table 3-4 provides some generic estimates. PET data for specific cities are available in Appendix B.

TABLE 3-4: PET RATES BASED ON CLIMATE			
Climate	Definition (mid-summer)	PET (worst case, inches per day)	Application Efficiency
Cool Humid	<70° F >50% humidity	.10 - .15	95%
Cool Dry	<70° F <50% humidity	.15 - .20	95%
Warm Humid	70° - 90° F >50% humidity	.15 - .20	90%
Warm Dry	70° - 90° F <50% humidity	.20 - .25	90%
Hot Humid	>90° F >50% humidity	.20 - .30	85%
Hot Dry	>90° F <50% humidity	.30 - .45	85%

EXAMPLE
 In a warm, dry climate where mid-summer temperatures are between 70 and 90 degrees Fahrenheit, and the humidity is typically less than 50 percent, the worst-case evapotranspiration rate is .20 to .25 inches per day and application efficiency is 90 percent.

You will use the climate and PET data to help determine the water requirements of the landscape.

Another factor that is related to climate is application efficiency. No irrigation system is 100 percent efficient; the efficiency is influenced by climate, system design, installation, and maintenance. However, since low-volume irrigation systems apply water directly to plant root zones, the efficiency is much greater than with conventional irrigation.

Table 3-4 includes estimated application-efficiency data of drip irrigation equipment for each type of climate. Enter the application efficiency in the space provided on your Site Data Worksheet.

- ⑤ Hydrozones** A hydrozone is an area containing plants that will be irrigated on the same schedule, using the same irrigation method. In general, a hydrozone is served by one control zone or valve, though more than one valve may be required due to hydraulic constraints.



On your Site Data Worksheet, enter a general description of the plants in each hydrozone, such as “mixed ground cover and shrubs.” In some cases, this information will come from the planting plan; in other cases, you will collect the data from an actual site survey. Also, describe the planting density in each hydrozone, this will strongly influence the selection of emission devices.

For each hydrozone, enter the irrigation method to be used. At this point, you may simply want to distinguish low-volume hydrozones from other areas requiring conventional turf rotors or spray heads.

Chapter 3 Review

To check your understanding of the material covered in Chapter 3, complete this review. The review includes a description of a sample property, a plot plan of the property (Figure 3-3) and a partially completed Site Data Worksheet (Figure 3-4).

Sample Property

For your convenience, we will be working with the same sample property throughout this manual. A plot plan of the property can be found on page 16. Refer to the Sample Plot Plan and read the description below.

Description

The sample property is the Doyle residence, located in Southern California. As the plot plan shows, this wedge-shaped property contains a house and detached garage. It also includes a concrete patio at the rear of the house, as well as a front walkway and several concrete parking slabs. The north and west sides of the house are surrounded by gravel walkways.

Hydrozones

As a preliminary design step, we have identified ten separate hydrozones on the property. Hydrozones 1 - 4 are turf areas that will be irrigated by conventional rotors or spray heads. Of course, we highly recommend quality Rain Bird rotors and spray heads. Hydrozones 5 - 10 have been identified as low-volume irrigation zones. They include the following:

- | | |
|--------------|---------------------------------------------------------------------------------------------------------------------------------------------------------------------------------------------------------------------------------|
| Hydrozone 5 | This hydrozone contains a single row of eight dwarf cypress trees along the boundary fence. |
| Hydrozone 6 | This hydrozone also contains a row of dwarf cypress trees along the south fence. |
| Hydrozone 7 | This hydrozone includes two irregularly shaped mixed planting areas on either side of the front walkway. The dominant plant is ground cover, along with two rows of medium-sized shrubs, two ferns, and several smaller shrubs. |
| Hydrozone 8 | This hydrozone includes a row of large shrubs planted approximately 5 feet apart. |
| Hydrozone 9 | This hydrozone has been reserved for a vegetable garden, which is not yet planted. |
| Hydrozone 10 | This hydrozone includes sparse plantings close to the house and hanging and container plants on the front porch. |

Figure 3-3: Sample Plot Plan—Doyle Residence

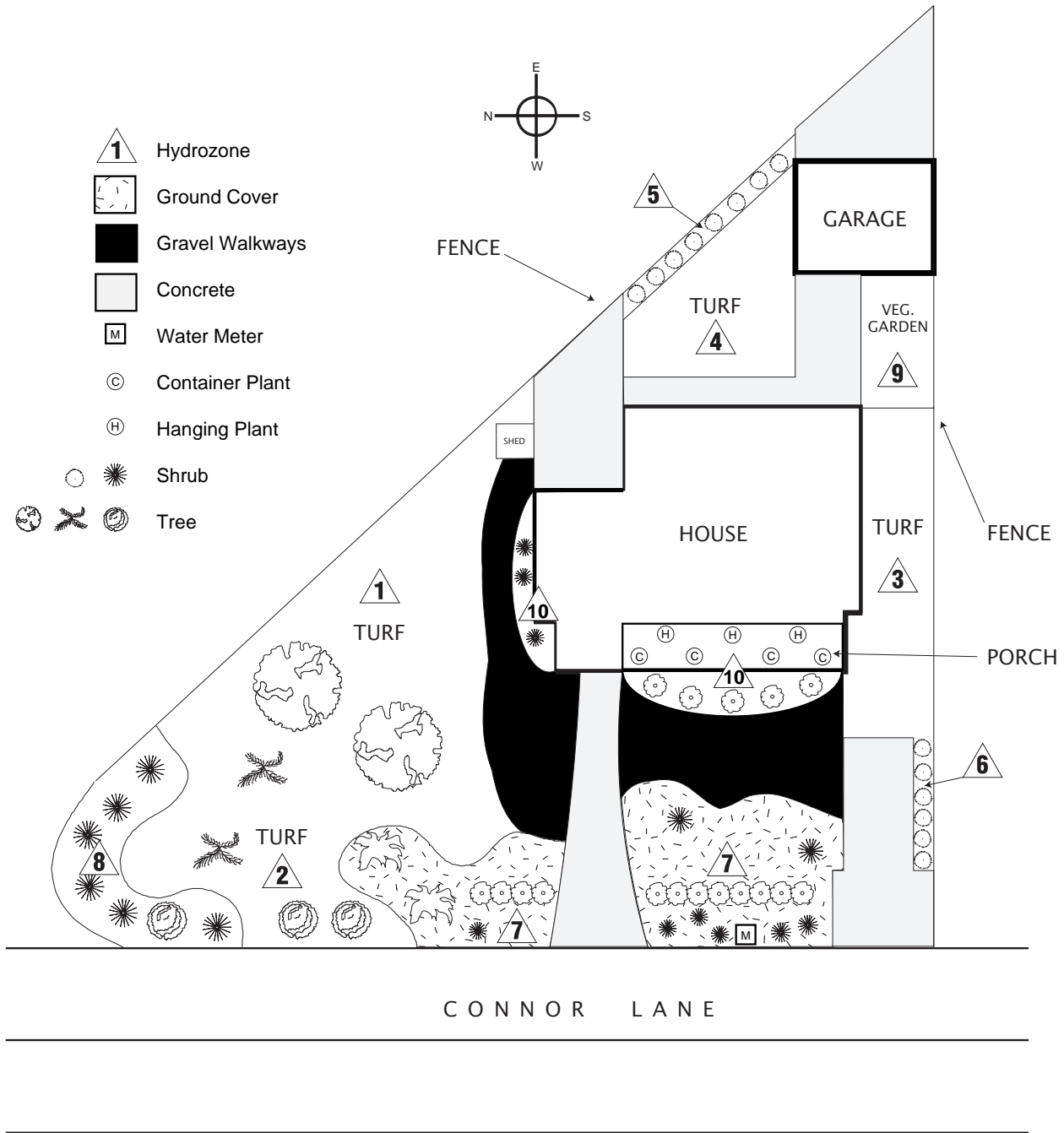

Figure 3-4: Sample Site Data Worksheet—Doyle Residence

SITE DATA WORKSHEET			DATE JOB NUMBER																																												
<p>1 Site Information</p> <p>Name <u>John & Wendy Doyle</u></p> <p>Address <u>7836 Connor Lane</u></p> <p>City <u>Brighton</u> State <u>CA</u> Zip <u>92867</u></p> <p>Contact <u>John</u></p> <p>Day Phone <u>714-555-8136</u> Eve. Phone <u>714-555-1089</u></p> <p>Pipe Requirements _____</p> <p>Specs on File <input checked="" type="checkbox"/> Yes <input type="checkbox"/> No</p> <p>Permits required? <input checked="" type="checkbox"/> Yes <input type="checkbox"/> No</p> <p>Cost _____</p>	<p>2 Water Source</p> <p><input checked="" type="checkbox"/> City Water</p> <p><input type="checkbox"/> Well:</p> <p style="margin-left: 20px;"><input type="checkbox"/> Sub <input type="checkbox"/> Centrifugal HP _____ PSI _____ GPM _____</p> <p><input type="checkbox"/> Surface Water</p> <p><input type="checkbox"/> Effluent</p> <p>Water Quality: <input checked="" type="checkbox"/> Good <input type="checkbox"/> Fair <input type="checkbox"/> Poor</p> <p>Water Purveyor <u>City of Brighton</u></p> <p>Contact <u>Dolores Martinez</u></p> <p>Phone <u>714-555-2591</u></p> <p>Meter Location <u>W side, S of front walk</u></p> <p>Meter size (inches) <u>5/8"</u></p> <p>Service Line Type and Size <u>3/4" copper</u></p> <p>Static Pressure (PSI at meter) <u>60 PSI</u></p> <p>Elevation change (± feet) <u>N/A</u></p>	<p>Notes</p> <p><u>Hydrozone 9, vegetable garden, not yet planted.</u></p> <p>_____</p> <p>_____</p> <p>_____</p> <p>_____</p> <p>_____</p> <p>_____</p> <p>_____</p> <p>_____</p> <p>_____</p> <p>_____</p>																																													
<p>3 Soil Type</p> <p><input type="checkbox"/> Coarse</p> <p><input checked="" type="checkbox"/> Medium</p> <p><input type="checkbox"/> Fine</p>	<p>4 Climate and PET</p> <p><input type="checkbox"/> Cool Humid <input type="checkbox"/> Cool Dry</p> <p><input type="checkbox"/> Warm Humid <input checked="" type="checkbox"/> Warm Dry</p> <p><input type="checkbox"/> Hot Humid <input type="checkbox"/> Hot Dry</p> <p>Worst case daily PET (in. per day): _____</p> <p>Application Efficiency (%): _____</p>																																														
<p>5 Hydrozones (Attach sketch of property)</p> <table border="1" style="width: 100%; border-collapse: collapse; text-align: center;"> <thead> <tr style="background-color: #333; color: white;"> <th>#</th> <th>DESCRIPTION</th> <th>DENSITY</th> <th>IRRIGATION METHOD</th> </tr> </thead> <tbody> <tr><td>1.</td><td>Turf</td><td>n/a</td><td>rotors</td></tr> <tr><td>2.</td><td>Turf</td><td>n/a</td><td>spray heads</td></tr> <tr><td>3.</td><td>Turf</td><td>n/a</td><td>spray heads</td></tr> <tr><td>4.</td><td>Turf</td><td>n/a</td><td>spray heads</td></tr> <tr><td>5.</td><td>Dwarf cypress</td><td>sparse</td><td>low-volume</td></tr> <tr><td>6.</td><td>Dwarf cypress</td><td>sparse</td><td>low-volume</td></tr> <tr><td>7.</td><td>Mixed G.C. & shrubs</td><td>_____</td><td>low-volume</td></tr> <tr><td>8.</td><td>Shrubs</td><td>sparse</td><td>low-volume</td></tr> <tr><td>9.</td><td>Vegetables</td><td>_____</td><td>low-volume</td></tr> <tr><td>10.</td><td>Shrubs/containers on porch</td><td>sparse</td><td>low-volume</td></tr> </tbody> </table>				#	DESCRIPTION	DENSITY	IRRIGATION METHOD	1.	Turf	n/a	rotors	2.	Turf	n/a	spray heads	3.	Turf	n/a	spray heads	4.	Turf	n/a	spray heads	5.	Dwarf cypress	sparse	low-volume	6.	Dwarf cypress	sparse	low-volume	7.	Mixed G.C. & shrubs	_____	low-volume	8.	Shrubs	sparse	low-volume	9.	Vegetables	_____	low-volume	10.	Shrubs/containers on porch	sparse	low-volume
#	DESCRIPTION	DENSITY	IRRIGATION METHOD																																												
1.	Turf	n/a	rotors																																												
2.	Turf	n/a	spray heads																																												
3.	Turf	n/a	spray heads																																												
4.	Turf	n/a	spray heads																																												
5.	Dwarf cypress	sparse	low-volume																																												
6.	Dwarf cypress	sparse	low-volume																																												
7.	Mixed G.C. & shrubs	_____	low-volume																																												
8.	Shrubs	sparse	low-volume																																												
9.	Vegetables	_____	low-volume																																												
10.	Shrubs/containers on porch	sparse	low-volume																																												

Site Data Look at Figure 3-4: Sample Site Data Worksheet above that has been partially completed for this property. Using this worksheet, complete the items below.

1. Section 4 of the Worksheet indicates that the climate is “Warm Dry.” What is the actual worst-case daily PET for this type of climate, according to Table 3-4? Fill in this figure on the sample Site Data Worksheet.
2. What is the application efficiency for a low-volume system in a Warm Dry climate according to Table 3-4? Fill in this figure on the sample Site Data Worksheet.
3. Hydrozone 7 is completely covered with ground cover. It also includes shrubs and trees. Enter your best estimate of the hydrozone’s density on the sample Site Data Worksheet.
4. Hydrozone 9 will be a vegetable garden when it is planted. What density do you think should be used to plan for this hydrozone? Enter your estimate on the sample Site Data Worksheet.

Suggested answers for these four items can be found on the last page of this chapter. Check your answers with this answer key.



Answer Key Check your answers to the review items with the correct answers below.

1. PET = .20 - .25 inches per day
2. Application efficiency = 90%
3. Hydrozone 7: Dense plantings
4. Hydrozone 9: Dense plantings

4

DETERMINE PLANT WATER REQUIREMENTS

The goal of Xerigation design is to apply water efficiently and effectively to each plant or group of plants in the landscape. To do this, you will need to estimate the daily water requirements of the various plant material in your landscape.

Individual, sparsely arranged plants will be irrigated by individual emitters or individual micro-bubblers. The water requirement for these plants is measured in *gallons per day*.

Groups of densely arranged plants will be irrigated by micro-sprays, Xeri-Pop[™] micro-spray pop-ups or Landscape Dripline inline emitter tubing. These are all designed to distribute a precise amount of water over a fixed area. Like conventional irrigation, the water requirement for densely arranged plants is measured in *inches per day*.

To help you calculate the water requirements and plan the rest of your low-volume installation, we have provided two hydrozone design worksheets: one for densely planted hydrozones (Figure 4-1) and one for sparsely planted hydrozones (Figure 4-2). Full-size samples that you can photocopy are included in Appendix D of this manual.

At the end of Chapter 7, you will find a partially completed sample worksheet. This can serve as a guide as you read the following descriptions.



Figure 4-1:
Dense
Hydrozone
Design
Worksheet

LOW-VOLUME DESIGN WORKSHEET: DENSE HYDROZONE

DATE _____
JOB NUMBER _____

1 Site Information

Name _____
Address _____
City _____ State _____ Zip _____
Contact _____
Day Phone _____ Eve. Phone _____
Daily PET (inches per day) _____
Application Efficiency _____
Soil Type: Coarse
 Medium
 Fine

Planting Scheme

Ground Cover Only
 Ground Cover/Trees
 Ground Cover /Shrubs
 Ground Cover/Shrubs/Trees
 Shrubs/Trees
 Shrubs Only

Base Plant

Ground Cover
 Shrubs

Emitter Spacing

12"
 18"
 24"
 36"

1

1 HYDROZONE

DESCRIPTION

5 SYSTEM RUN TIME

2 **Base Plant**

BASE PLANT SPECIES	SPECIES FACTOR	DENSITY FACTOR	MICROCLIMATE FACTOR	K _c	3 WATER REQUIREMENT	4 EMITTER FLOW RATE	5 ADJUSTED EDR

Plant Canopy Area
0.7854 X Diameter X Diameter = Square Feet

Water Requirement
K_c X PET = Inches per Day

Water Requirement
 $\frac{.623 \times \text{Area} \times K_c \times \text{PET}}{\text{Application Efficiency}} = \text{Gallons per Day (GPD)}$

2 **Non-Base Plants**

ADDITIONAL PLANT SPECIES	SPECIES FACTOR	DENSITY FACTOR	MICROCLIMATE FACTOR	K _c	3 PLANT DIAMETER (FT.)	CANOPY AREA (SQ. FT.)	WATER REQUIREMENT (GPD)	6 4 TYPE	EMISSION DEVICES FLOW	QUANTITY	SPACING

LOW-VOLUME DESIGN WORKSHEET: SPARSE HYDROZONE

DATE _____
JOB NUMBER _____

1 Site Information

Name _____
Address _____
City _____ State _____ Zip _____
Contact _____
Day Phone _____ Eve. Phone _____
Daily PET (inches per day) _____
Application Efficiency _____
Soil Type: Coarse
 Medium
 Fine

5

1

5 SYSTEM RUN TIME

1 HYDROZONE

DESCRIPTION

2 **Minimum Area To Be Wetted**
0.7854 X Diameter X Diameter X 50% = Square Feet

Water Requirement
 $\frac{.623 \times \text{Area} \times K_c \times \text{PET}}{\text{Application Efficiency}} = \text{Gallons per Day (GPD)}$

2

PLANT SPECIES	SPECIES FACTOR	DENSITY FACTOR	MICROCLIMATE FACTOR	K _c	3 PLANT DIAMETER (FT.)	CANOPY AREA (SQ. FT.)	WATER REQUIREMENT (GPD)	4 6 TYPE	EMISSION DEVICES FLOW	QUANTITY	SPACING

Calculating Water Requirements

- ∂ **Gather Site Information** Begin by filling in the identifying information about the site and the hydrozone at the top of the worksheet. Transfer the Daily PET, Application Efficiency, and Soil Type from the Dense Hydrozone Worksheet (Figure 7-1 at the end of Chapter 7) to the appropriate places on the dense and sparse hydrozone worksheets (Figures 4-1 and 4-2, page 20). This information will be very important when you compute the water requirements of the individual plants in the hydrozone.

Be sure to write the number of the hydrozone in the box at the upper right corner of the worksheet. You may also want to include a one- or two-word description, such as “front planter.”

Dense Hydrozones Only

In a densely planted hydrozone, you must first identify the “base plant.” The base plant is the plant material in the hydrozone that uses the least amount of water per day. Often, it is also the plant that covers the majority of the planted area—generally either ground cover or shrubs. Use Table 4-1 to help you identify the base plant for your hydrozone.

TABLE 4-1: BASE PLANTS IN DENSE HYDROZONES	
Planting Scheme	Base Plant
Ground cover only	Ground cover
Ground cover and trees	Ground cover
Ground cover and shrubs	Ground cover
Shrubs and trees	Shrubs
Shrubs only	Shrubs
Ground cover, trees, and shrubs	Ground cover

- Σ **Calculate K_c** As described in Chapter 3, the potential evapotranspiration rate (PET) describes the amount of water used by a specific variety of grass under ideal moisture conditions. To calculate the exact water requirement of an individual plant, you must adjust PET to account for specific conditions and the needs of the plant. The adjustment factor is called the plant’s “ K_c ”. The terms “crop coefficient” and “plant factor” are also sometimes used.

Use the spaces on the worksheets to calculate K_c for each plant in your hydrozone. Note that for densely planted hydrozones there are separate spaces for recording information on base plants and non-base plants.

Plant Species

It’s very important that you accurately list each of the plants in the hydrozone. In some cases, this information will come from the planting plan; in other cases, you will collect the data from an actual site survey.

Species Factor

The species factor is an adjustment to PET that reflects the amount of water that a particular species of plant needs relative to turf grass. The range can be from 0.2 for plants like cactus and succulents that require little water, up to 0.9 for plants like ferns that require a great deal of water.

On the dense hydrozone worksheet (Figure 4-1, page 20), indicate the estimated range of the plant's species factor: "low," "average" or "high" based on Table 4-2 below. Note this in the top portion of the "species factor" box. Later, you can assign a numerical value to the species factor, again using Table 4-2 as a guideline.

TABLE 4-2: ESTIMATED SPECIES FACTORS			
Plant Type	Low	Average	High
Trees	0.2	0.5	0.9
Shrubs	0.2	0.5	0.7
Ground covers	0.2	0.5	0.7
Mixed trees, shrubs, ground covers	0.2	0.5	0.9

EXAMPLE

Assume that you have a hydrozone planted only with shrubs that require a great deal of water. If you locate the "Shrubs" row in Table 4-2 and read across to the "High" column, you'll find that the species factor is 0.7. "High" would be entered in the top half of the species factor box on the worksheet and "0.7" would be entered in the bottom half of the species factor box.

Density Factor

The density factor indicates how densely the plants are placed in the hydrozone. As the density of the plants increases, so does the density factor.

In the top portion of the worksheet's "density factor" box, indicate the approximate range of the plant's density factor: low, average, or high. Later, you can assign a value to the density factor, using Table 4-3 as a guideline.

TABLE 4-3: ESTIMATED DENSITY FACTORS			
Plant Type	Low	Average	High
Trees	0.5	1.0	1.3
Shrubs	0.5	1.0	1.1
Ground covers	0.5	1.0	1.1
Mixed trees, shrubs, ground cover	0.6	1.1	1.3

EXAMPLE

Assume that you have a hydrozone that contains only sparsely planted shrubs. Locate the row labeled “Shrubs,” and read across to the “Low” column. You’ll find that the density factor for this plant is 0.5. “Low” would be entered in the top half of the “density factor” box on your worksheet and “0.5” would be entered in the bottom half of the box.

Microclimate Factor

A microclimate is a sub-climate. Even small residential sites will have areas with entirely different climatic conditions. For example, areas in direct sunlight versus areas in the shade. The two areas may have identical plantings but the water requirements of the plants will be very different. Ideally, each microclimate would be zoned separately. However, when this is not practical, drip irrigation is flexible enough to meet the needs of these special conditions.

A less obvious example of different microclimates might be areas close to a house or a driveway, where reflective heat will change the water requirements compared to an area surrounded by turf. In fact, experiments have shown that plantings surrounded by pavement may have a PET as much as fifty percent higher than the same types of plants in a park setting.

For each plant in the hydrozone, record on your worksheet an estimate of the microclimate: low, average, or high, based on the water adjustment the area will require. A “low” microclimate will require less water, and a “high” microclimate will require more water. Record your estimate in the top portion of the “microclimate factor” box. Later, you can assign a value to the microclimate factor, using Table 4-4 as a guideline.

TABLE 4-4: ESTIMATED MICROCLIMATE FACTORS

Plant Type	Low	Average	High
Trees	0.5	1.0	1.4
Shrubs	0.5	1.0	1.3
Ground covers	0.5	1.0	1.2
Mixed trees, shrubs, ground cover	0.5	1.0	1.4

EXAMPLE

Assume that you have a hydrozone planted with shrubs only. This hydrozone is adjacent to the street, and it is surrounded by cement walkways. Therefore, you estimate the microclimate factor as high. If you locate the “Shrubs” row in Table 4-4 and read across to the “High” column, you’ll find that the microclimate factor for this plant is 1.3. “High” would be entered in the top half of the “microclimate factor” box and “1.3” would be entered in the bottom half of the box on your worksheet.

K_c

Once you have collected all the information about the plants in the hydrozone, and assigned the values for species, density, and microclimate factors, you can calculate the K_c for each plant. K_c indicates the plant's need for water as it relates to the established PET rate in the area.

To calculate the K_c values, simply multiply each plant's species factor, density factor, and microclimate factor. Round this number to the nearest tenth, and record it in the " K_c " column of the worksheet.

EXAMPLE

You're designing for a hydrozone that includes only sparsely planted shrubs that require a great deal of supplemental water. Therefore, the species factor is high (0.7), and the density factor is low (0.5). The hydrozone is adjacent to the street, and it is surrounded by cement walkways, so you've assigned it a high microclimate factor (1.3).

To calculate K_c you multiply:

$$0.7 \times 0.5 \times 1.3 = 0.455$$

After rounding to the nearest tenth, you find that the K_c for this shrub is 0.5. Enter this number in the " K_c " box on your worksheet.

③ Calculate Water Requirement for Dense Plantings

The water requirement for the base plant in a densely planted hydrozone is measured in inches per day. To calculate the water requirement in *inches per day*, the formula is:

$$\text{Water Requirement (inches per day)} = K_c \times \text{PET}$$

EXAMPLE:

Assume the PET for our site is 0.35 inches per day (an arbitrary number selected for this example). Previously, we calculated a K_c of 0.5. To determine the water requirement, multiply these two figures together ($0.35 \times 0.5 = 0.175$). The water requirement for the base plant under these circumstances is .175 inches per day.

After rounding to the nearest tenth, you find that the water requirement for this site is 0.2 inches per day.

③ Calculate Water Requirement for Individual Plants in a Sparse Hydrozone

The water requirement for individual plants in a sparse planting scheme is measured in *gallons per day* (GPD). To calculate the water requirement for an individual plant, you must first calculate the area of the plant's root zone. You can approximate the area of the root zone by using the area of the plant's canopy.

Plant Diameter

For each plant, enter into the worksheet the diameter of the plant's mature canopy. That means that if immature plants are currently in place, you will need to estimate how big they will grow as they mature. For the water requirement calculation, you should estimate the diameter of the plant's canopy in feet.



Area of Plant Canopy

Use the following formula to determine the area of the plant's canopy.

$$\text{Canopy Area (sq. ft.)} = .7854 \times \text{Diameter (ft.)} \times \text{Diameter (ft.)}$$

EXAMPLE

You are calculating the area of the root zone for a large shrub. The mature canopy of the shrub is 6.5 feet in diameter. To calculate the area, you multiply:

$$.7854 \times 6.5 \text{ ft.} \times 6.5 \text{ ft.} = 33.18315 \text{ sq. ft.}$$

After rounding to the nearest tenth, you find that the area of the root zone is 33.2 sq. ft.

Application Efficiency

To determine the application efficiency (the efficiency with which water is actually made available to plants) refer to the Site Data worksheet on page 11 and identify the climate type. In the worksheet, the climate was identified as warm, dry. From Table 3-4, a warm, dry climate results in an application efficiency of 90 percent. For use in the GPD (gallons per day) formula shown below, convert the percentage to a decimal, i.e., 0.90.

Water Requirement (GPD)

The water requirement for individual plants is measured in gallons per day. To compute the water requirement for an individual plant, you must know the area of the plant's root zone, its K_c , the worst case PET rate for the area, and the application efficiency of the irrigation system. The formula is:

$$\text{Gallons per Day per Plant} = \frac{.623 \times \text{Canopy Area (sq. ft.)} \times K_c \times \text{PET}}{\text{Application Efficiency}}$$

EXAMPLE

You're calculating the water requirement for the shrub used in the previous examples. At this point, you know the following information:

Area of plant canopy = 33.2 sq. ft.

$K_c = 0.5$

PET (worst case, mid-summer) = .20 in./day

Application Efficiency = .90

To determine the plant's water requirement, you calculate:

$$\frac{.623 \times 33.2 \text{ sq. ft.} \times 0.5 \times .20 \text{ in.}}{.90} = 2.298177 \text{ GPD}$$

After rounding to the nearest tenth, you find that the water requirement for this plant is 2.3 gallons per day.

Calculate the water requirement for each plant in the hydrozone, and record your results in the spaces provided on the worksheet.



Chapter 4 Review

To check your understanding of the material covered in Chapter 4, complete this review. The review is based on the partially completed hydrozone worksheet which is located at the end of Chapter 7.

1. The worksheet indicates that the base plant is a ground cover: Ice Plant. Using the information in the sample worksheet, and Tables 4-2 through 4-4, calculate the K_c for the ice plant.
2. The non-base plants in this hydrozone include two ferns. Calculate the K_c for the ferns.
3. Calculate the water requirement for the base plant. Remember that for dense base plants, the water requirement is measured in inches per day.
4. Calculate the water requirement for the two ferns (5-foot diameter). Remember that the water requirement for individual plants is calculated in gallons per day. To calculate the water requirement, you must first calculate the area of the plant canopy.



Answer Key Check your answers to the review items with the correct answers below.

1. Species Factor = 0.2
Density Factor = 1.1
Microclimate Factor = 1.2

 $K_c = 0.3$
2. Species Factor = 0.7
Density Factor = 0.5
Microclimate Factor = 1.3

 $K_c = 0.5$
3. Water requirement = 0.06 inches per day
4. Canopy Area = 19.6 square feet
Water Requirement = 1.4 gallons per day



5

IRRIGATE BASE PLANTS

In this chapter, you will:

1. Identify the hydrozone's base plant.
2. Select emission devices for the base plant.

This chapter will continue to use the Hydrozone Design Worksheets introduced in the previous chapter. Use the sample worksheet at the end of Chapter 7 as a reference while reading this chapter.

Identifying the Base Plant

If you have not already identified the base plant, you must do so now.

Dense Plantings In a densely planted hydrozone, the base plant is the plant material with the lowest water requirement in the hydrozone. It is also typically the type of plant that covers the majority of the planted area—generally either ground cover or shrubs. For dense hydrozones, you identify the base plant as part of calculating the water requirement.

Sparse Plantings In a sparsely planted hydrozone, the base plant is the individual plant with the lowest water requirement. You will run your system just long enough to irrigate this base plant. You will design your system to deliver the required amount of water to all other plants in the time it takes to irrigate the base plant.

Estimate the water requirements of all the individual plants in the hydrozone, and choose the plant with the lowest water requirement as your base plant. Enter this plant in the “Base Plant” section of your design worksheet for easy reference.

④ Emission Devices

To select the best emission device or devices to irrigate the base plant, start by considering the following:

- **Types of Plants.** As we have already seen, the primary factor that affects your design is the water requirement of the individual plants or groups of plants in the landscape.
- **Intended Use.** Factors such as traffic and the threat of vandalism will affect your choice of distribution components and emission devices. For example, micro-sprays and micro-bubblers are probably not appropriate in high-traffic areas. These emission devices can also create overspray.

In areas that are prone to vandalism, system components that can be installed below grade are better than above-ground devices. Landscape Dripline and Xeri-Pop micro-spray pop-ups would be good choices because they are out of sight when not in operation.

- **Size of Planted Area.** It may be too labor intensive and costly to install individual emitters over a very large planted area. In these cases, it might be more economical to use Landscape Dripline, micro-sprays or Xeri-Pops. For extremely large areas, consider using conventional sprays or rotary heads with a separate drip zone around the perimeter to eliminate unwanted overspray onto walkways or streets.
- **Soil Type and Infiltration Rate.** As shown in Chapter 2, different soil types absorb water in different ways. In coarse (sandy) soil, water tends to percolate downward, while in fine (clay) soil the moisture tends to spread horizontally before moving vertically.

When irrigating areas with very coarse soil, consider using higher flow PC Modules or micro-bubblers rather than emitters. Conversely, avoid higher flow PC Modules and micro-bubblers when irrigating very fine clay soil, unless you build troughs or wells around each plant being watered. Choosing emitters with low flow rates will help avoid runoff.

- **Watering Window.** The watering window is the amount of time available for irrigation each day. For example, some sites might require that conventional irrigation take place during the night to avoid problems with overspray or runoff or to follow municipal regulations. A low-volume system using emitters may increase the watering window by permitting irrigation to take place during the day. Micro-sprays and micro-bubblers may have a more limited watering window than emitters or Landscape Dripline systems because they discharge water into the air, making them more similar to conventional sprays and rotors.



- **Cost.** The equipment cost for low-volume systems is generally lower than conventional systems. However, in many cases the installation cost will be higher for commercial drip systems and lower for residential low-volume systems. This is because commercial drip systems tend to be installed on either buried PVC or high-density polyethylene tubing. Residential drip systems typically use poly drip tubing installed at grade, which can be installed more quickly (once crews are familiar with low-volume irrigation installation techniques).

Labor Cost Considerations Among low-volume systems, there will also be labor cost differences. For example, a system requiring many individual emitters may cost more than one that uses a smaller number of micro-sprays or inline emitter tubing. The Xerigation product line includes a variety of emission devices designed for many different applications. Table 5-1 will help you select the most appropriate emission devices for each plant or group of plants in your landscape. For more information about these products, see the Xerigation section of the Rain Bird Landscape Irrigation Products Catalog.

TABLE 5-1: XERIGATION EMISSION DEVICE APPLICATION MATRIX

Planting Scheme	Application	Emission Device*	Outlets	Pressure Compensates	Flow Rate	Filter Included	Inlet	Filter Required
Dense	Ground cover, beds, mass shrub plantings	Landscape Dripline	12", 18", 24" spacing	Yes	0.6, 0.9 GPH	No	N/A	120-Mesh 125-Micron
	Ground cover, beds, mass shrub plantings	Xeri-Sprays adjustable	Quarter, half, full circle	No	0 - 31 GPH	No	10-32 self-tapping threads	100-Mesh 150-Micron
	Ground cover, beds, mass shrub plantings	Xeri-Pop with Multi-Port Nozzle	5'x5' Square, 5'x10' Strip, Center Strip, Three-Quarter Strip, 10'x10' Full Square	No	0- 42 GPH	Yes 30-Mesh	Barb that accepts 1/4" distribution tubing	100-Mesh 150-Micron
Sparse	Individual plants, shrubs, trees, containers, hanging baskets	Xeri-Bug Single Outlet Emitter	1	Yes	0.5, 1.0, 2.0 GPH	No	Self-piercing barb	<u>GPH Mesh/Micron</u> 0.5 200/75 1.0 150/100 2.0 150/100
	Anywhere clogging is a concern or there is heavy mineral content in the water	Xeri-Bubblers adjustable	Half & full streams, umbrella	No	Streams: 0-13 GPH Umbrella: 0-35 GPH	No	10-32 self-tapping threads	100-Mesh 150-Micron
	Individual plants. Retrofits to PVC risers.	Shrub Xeri-Bug Single Outlet Emitter	1	Yes	1.0, 2.0, 2.0 GPH	No	1/2" FPT	150-Mesh 100-Micron
	Larger shrubs and trees	Pressure Compensating Modules	1	Yes	5, 7, 10, 12, 18, 24 GPH	No	Self-piercing barb	100-Mesh 150-Micron
	Grouped plantings; mixed or matched	Xeri-Bird-8	8	Yes	Variable based on selected emitters and/or PC Modules	Yes 200-Mesh 75-Micron	1/2" FPT	Based on emission device selected.
	Grouped plantings; matched	Multi-outlet Xeri-Bug, Multi-outlet Shrub Xeri-Bug	6	Yes	1.0 GPH per outlet	No	Self-piercing barb or 1/2" FPT	150-Mesh 100-Micron

* See following pages for more information on choosing an emission device.

Dense Plantings

Table 5-1 shows that for dense plantings, the best choices of emission devices are Landscape Dripline, Xeri-Sprays and Xeri-Pops. Each of these choices has advantages for certain applications, however Landscape Dripline is certainly the most water efficient because it does not spray any water into the air.

Landscape Dripline



Inline emitter tubing is polyethylene distribution tubing with emitters pre-installed at the factory at preset intervals. Rain Bird's Landscape Dripline goes further than today's conventional inline tubing products because it provides unmatched clog resistance and lowers installation costs.

Landscape Dripline is a closed-loop grid of inline emitter tubing that, when properly spaced, delivers full coverage to a planting area (see Figure 5-1). The soil type and planting scheme influence which flow rate, emitter/lateral spacing, length of lateral and configuration you choose. Landscape Dripline is easy to install and maintain because:

- Built-in pressure compensation ensures consistent flow from each inline emitter throughout the entire length of the tubing and throughout its 8 - 60 PSI (0,5 - 4,0 Bars) operating range.
- Rain Bird's patented inline emitter pressure compensates by effectively lengthening the flow path instead of reducing its size. This significantly increases its clog resistance.
- Dual exit ports for each emitter act like built in micro air relief valves. When combined with the inline emitter's cylindrical design, the need for, and cost of, installing air relief valves and automatic flush valves is eliminated. This is the case whenever the tubing is installed at grade or in a 1" - 2" (25 - 50 mm) deep trough and then mulched over. However, when installing Landscape Dripline subsurface in a non-grass application, install air relief valves at the highest points of the closed-loop grid.
- You can use compression or insert fittings to install.
- You can add emitters to the grid to water individual plants.

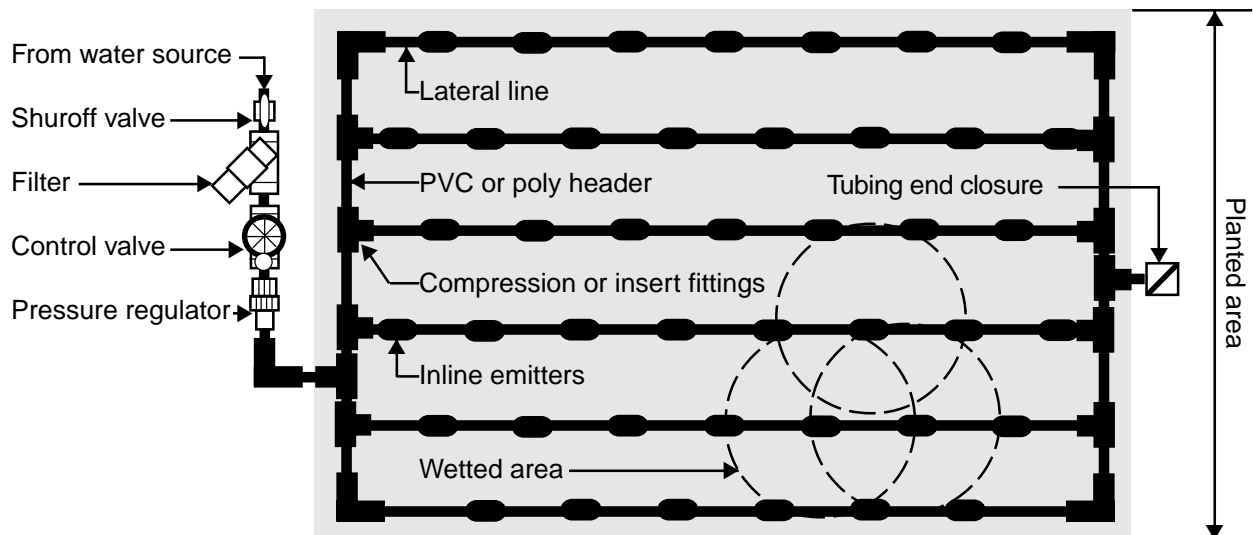

Figure 5-1: The Landscape Dripline System



Table 5-2 shows Landscape Dripline’s selection of flow rates, spacings and coil lengths for a variety of conditions.

TABLE 5-2: LANDSCAPE DRIPLINE CHOICES			
Model	Flow Rate	Emitter Spacing	Length of Tubing
LD06-12-100	0.6 GPH	12"	100'
LD06-12-250	0.6 GPH	12"	250'
LD06-12-500	0.6 GPH	12"	500'
LD06-18-100	0.6 GPH	18"	100'
LD06-18-250	0.6 GPH	18"	250'
LD06-18-500	0.6 GPH	18"	500'
LD06-24-100	0.6 GPH	24"	100'
LD06-24-500	0.6 GPH	24"	500'
LD09-12-100	0.9 GPH	12"	100'
LD09-12-250	0.9 GPH	12"	250'
LD09-12-500	0.9 GPH	12"	500'
LD09-18-100	0.9 GPH	18"	100'
LD09-18-250	0.9 GPH	18"	250'
LD09-18-500	0.9 GPH	18"	500'
LD09-24-100	0.9 GPH	24"	100'
LD09-24-500	0.9 GPH	24"	500'

Use Table 5-3 to select the correct Landscape Dripline emitter flow rate and emitter spacing for your base plant. First locate the soil type, then select the emitter spacing and flow rate indicated in the right hand columns. Use 0.6 GPH emitters for fine soils to avoid runoff and 0.9 GPH emitters in medium and coarse soils for maximum coverage. Note your selection in the space provided on the worksheet in Chapter 7.

Actual inline tubing spacing is then determined by the maximum width of the planted area, evenly divided. See the Lateral Line Spacing Worksheet (Figure 5-2, page 35) and Figure 5-3 for more information.

TABLE 5-3: LANDSCAPE DRIPLINE SPACINGS AND FLOW RATES		
Soil Type	Emitter & Lateral Spacing	Flow Rate
Fine	24"	0.6
Medium	18"	0.9
Coarse	12"	0.9

Use the worksheet below to determine actual lateral spacing.

LATERAL LINE SPACING WORKSHEET			
Follow the example below to determine the space between lateral lines:			
To Get This:	Do This:	Calculations	Totals
1. Width of the planted area	Measure the width in feet		5 feet
2. Width of planted area in inches:	Multiply feet by 12 to get inches	$5' \times 12" =$	60 inches
3. Actual width of the grid:	Subtract edge offset (multiply $2 \times 2 = 4$)*	$60" - 4" =$	56 inches
4. No. of spaces between laterals:	Divide grid width by emitter spacing (12", 18" or 24")	$56" \div 12" =$	4.6 spaces
5. Actual no. of spaces:	Round up to the next whole number	4.6 =	5 spaces
6. Actual space between lateral lines:	Divide grid width by number of spaces in grid	$56" \div 5 \text{ spaces} =$	11.2"
7. No. of lateral line rows in the grid:	Add one to no. of spaces	$5 + 1 =$	6 rows
Use the worksheet below to determine the space between lateral lines for your system:			
To Get This:	Do This:	Calculations	Totals
1. Width of the planted area	Measure the width in feet		
2. Width of planted area in inches:	Multiply feet by 12 to get inches		
3. Actual width of the grid:	Subtract edge offset (multiply $2 \times 2 = 4$)*		
4. No. of spaces between laterals:	Divide grid width by emitter spacing (12", 18" or 24")		
5. Actual no. of spaces:	Round up to the next whole number		
6. Actual space between lateral lines:	Divide grid width by number of spaces in grid		
7. No. of lateral line rows in the grid:	Add one to no. of spaces		
* The edge offset is 2" from hardscape and 4" from non-hardscape.			

Figure 5-2: Lateral Line Spacing Worksheet

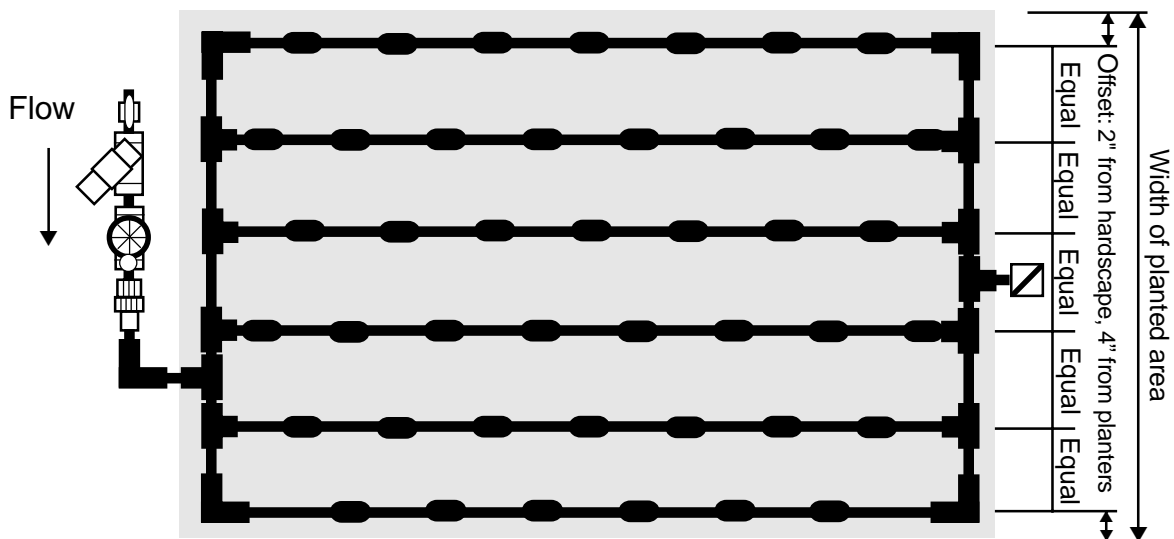

Figure 5-3: Equal Lateral Line Spacing

Landscape Dripline: A More Technical Approach

The preceding information about selecting the appropriate inline emitter flow rate and spacing for the proper design of a Landscape Dripline grid was based primarily on identifying the soil type of the planting area. In this section, we add one more factor to the selection criteria: the desired watering depth based on the plants' root zones.

Table 5-4, page 39, shows the estimated root depth for two common dense planting schemes along with the desired watering depth. Remember that since the top half of the plant's root zone is most active, (see Figure 1-1, page 3) that is where you want to deliver most of the water.

Use these figures as a guideline for your specific situation. Record your selection on the worksheet.

TABLE 5-4: MINIMUM RECOMMENDED WATERING DEPTHS		
Base Plant	Root Depth	Minimum Watering Depths
Ground Cover	12"-18"	6"-9"
Small Shrubs	18"-36"	9"-18"

EXAMPLE

If the hydrozone you are irrigating with Landscape Dripline tubing includes ground cover and shrubs, with the ground cover as the dominant plant that also requires less daily water than the shrubs, then the base plant root depth will be 12"-18". To irrigate at least half the depth of the root zone, your minimum watering depth will be 6"-9". In this case, the desired watering depth is determined by the ground cover in the landscape.

Emitter Spacing Versus Watering Depth

Figure 5-4 illustrates the emitter spacing required to water different soil types to the same depth in consistent, uniform soils. For a uniformly coarse soil, the ratio between emitter spacing and desired watering depth is 1:1, for a uniformly medium soil 2:1 and for a uniformly fine, clay-like soil 4:1.

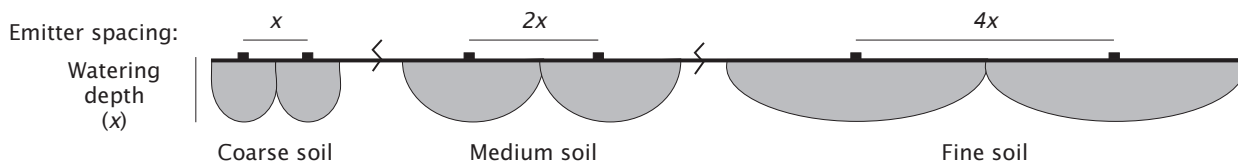

Figure 5-4: Emitter spacing in different soils



However, there is a limit to the horizontal spread of water by capillary action in the soil even when that soil has been well amended and is consistent throughout the planting area. As a result, you must be careful not to exceed the maximum allowable spacing of the emitters as shown in Table 5-5. If this maximum spacing is exceeded, dry spots between emitters will result and it is likely that salts will build up around the plants' roots.

TABLE 5-5: MAXIMUM EMISSION DEVICE SPACING (INCHES)			
Emitter Flow	Coarse	Medium	Fine
0.6 GPH	12.0	27.6	39.9
0.9 GPH	20.4	33.7	42.9
2.0 GPH	39.6	51.6	67.2

Applying The More Technical Approach

Use Table 5-6 to select the correct emitter spacing for your base plant. First locate the soil type, and then the desired watering depth. Select the emitter spacing indicated in the right hand column.

TABLE 5-6: RECOMMENDED EMITTER SPACING		
Soil Type	Minimum Desired Watering Depth	Emitter Spacing
Coarse	6"	Use Micro-Sprays 12" 18"
	12"	
	18"	
Medium	6"	12"
	9"	18"
	12"	24"
	18"	36"
Fine	6"	24"
	9"	36"
	12"	48"

EXAMPLE

To irrigate to a depth of 9" in medium soil, choose Landscape Dripline tubing with 0.9 or 0.6 GPH emitters spaced at 18" intervals and lateral spacing that does not exceed 18".

In many cases, you can choose the flow rate based on your preference for system run time; the higher the flow rate, the less time it takes to deliver a given amount of water to the plant. However, you should always use 0.6 GPH emitters for very fine soils to avoid runoff.

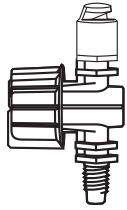

Xeri-Sprays™

Rain Bird's Xeri-Sprays (max. flow 31 GPH at 30 PSI) have higher flow rates than most drip emitters, but lower flow rates than conventional sprays (up to 216 GPH). They are best suited to irrigating large, densely planted areas such as large areas of ground cover. Avoid using Xeri-Sprays in windy conditions. Xeri-Sprays should be placed head-to-head to allow for at least a 50% overlap of the spray patterns. Xeri-Sprays will provide, on average, approximately one inch per hour of water.

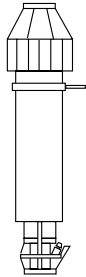

Xeri-Pop Series Micro-spray Pop-Ups

Rain Bird's XP Series Xeri-Pop micro-spray pop-ups are much like conventional pop-up spray heads except that they feature a 1/4" barb inlet instead of the traditional 1/2" threaded inlet. They accept 5, 8 and 10 Series MPR nozzles with flow rates of 45 GPH (0.75 GPM) or less. Xeri-Pops are available in 2", 4" or 6" pop-up models. They pop up to water and then pop down flush when not in operation so they are practically invisible and less vulnerable to damage. A 40 or 50 PSI pressure regulator is recommended for a Xeri-Pop zone.

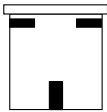

Multi-Port Spray Nozzle (available Spring 2000)

The Multi-Port spray nozzle is unique in that it provides five patterns in one low-flow micro-spray nozzle. Its patent-pending design is based on four independent flow quadrants that can be opened, much like an emitter hole is punched into drip tubing. The Multi-Port nozzle is compatible with all 1800 Series, UNI-Spray Series and Xeri-Pop micro-spray pop-ups. In addition, it is virtually mist-free at higher pressures of up to 70 PSI.

For non-turf applications, Xeri-Pops are ideal for:

- High traffic areas where vandalism, safety or aesthetics are a concern.
- Dense plantings where single-outlet emitters would be cost prohibitive to install and conventional spray heads would overspray. Xeri-Pops have a wide and adjustable area of coverage from a 5' x 5' quadrant up to a 10' x 10' square.
- Irregularly shaped planters to help avoid overspray.
- Use with PCS screens (0.1, 0.2, 0.3, 0.4 and 0.6 GPM) and 5 B Series bubbler nozzles to create a low-volume pop-up micro-bubbler that is easily visible when in operation. Provides water-saving benefits of drip with the low maintenance of pop-ups.

Sparse Plantings

Table 5-1 shows that for sparse plantings, the best choices of emission devices are Xeri-Bug emitters, Xeri-Bubblers, Pressure Compensating Modules and the Xeri-Bird-8. You can use 1.0 or 2.0 GPH emitters for most sparse planting schemes, and 0.5 GPH emitters for container plants and very fine soils. For larger shrubs and trees, choose pressure-compensating modules or Xeri-Bubblers to provide larger flows and to reduce the total number of emitters required. To eliminate possible runoff, consider the use of wells or troughs to capture the higher flow.

Selecting Emitters In general, use Table 5-7 below to guide your emission device selection. Remember that the less coarse or sandy the soil is, the more possibility of runoff. The more water a plant needs on a daily basis, the greater the need for higher flow emission devices to avoid installing an inordinate number of low-flow emitters. To address this challenge, consider the use of wells or troughs to capture the higher flow that exceeds the infiltration rate of the soil.

TABLE 5-7: EMISSION DEVICE SELECTION			
Soil Type	Emitter	PC-Module	Xeri-Bubbler
Coarse Soil	XB-20	PC-05, 07, 10	SXB, VXB
Medium Soil	XB-10, XB-20	PC-05	SXB, UXB
Fine Soil	XB-05	w/trough	w/trough

Recommended Emitter Placement

To assure optimal wetting of the root zone, the emitters should be spaced in a circle, 3/4 of the way between the trunk of the plant and its dripline. The dripline is where the edge of the tree canopy would cast its shadow on the ground with the sun directly overhead.

Tips for placing emitters (see also Figure 5-5):

- Use at least two emitters per plant.
- Place emitters so they are evenly spaced around the plant.
- Place emitters three-quarters of the way between the plant's trunk and the dripline.
- When 1/4" tubing runs exceed 5 feet, use a SPB-025 connector and install an emitter at the end of the 1/4" tubing run.
- Always use stakes and diffuser bug caps at the end of the 1/4" tubing for longer reliability.

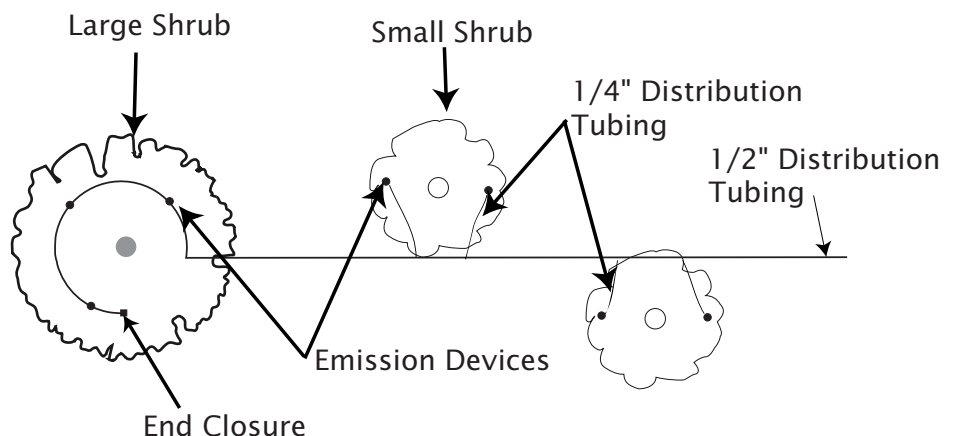

Figure 5-5: Emitter Placement



Calculating the Wetted Area

Given your soil type, select the appropriate emission device to avoid runoff. Next, determine the suggested spacing of your emitters based on the soil type and the desired watering depth. Use Tables 5-4 through 5-6 as a guideline. Next determine the area wetted by each of your emitters. The formula for the area wetted is:

$$\text{Area Wetted (sq. ft.)} = \text{Emitter Spacing (ft.)} \times \text{Emitter Spacing (ft.)} \times 0.7854$$

Table 5-8 provides the area wetted by emitters in the most common spacing patterns.

TABLE 5-8: AREA WETTED BY EACH EMITTER (SQ. FT.)			
Emitter Spacing	Coarse Soil	Medium Soil	Fine Soil
12" X 12"	0.8	1.6	3.1
18" X 18"	1.8	3.5	7.1
24" X 24"	3.1	6.3	12.6
36" X 36"	7.1	14.1	28.3

EXAMPLE

You are designing for a hydrozone that contains six azalea shrubs, each with a mature canopy of 4 feet, and two crepe myrtle trees, each with a canopy diameter of 10 feet. The soil type is coarse. The azaleas require 0.4 GPD and the crepe myrtles require 3.3 GPD. The azaleas, with the lowest water requirement, are the base plant.

Table 5-4 shows that the desired watering depth for small shrubs is approximately 18 inches. Table 5-6 shows that to reach a depth of 18 inches in coarse soil, you should space emitters 18 inches apart.

Table 5-8 shows that emitters spaced at 18 inches in coarse soil will each wet 1.8 square feet.

The minimum area to be wetted is a function of the plant's root zone. For most plants you can assume that the area of the plant's root zone is approximately the same as the area of its canopy. In general, the *minimum* area to be wetted should be one half of the area of the plant's mature canopy.

To determine the number of emitters required for each plant, divide the minimum area to be wetted by the area wetted by each emitter:

$$\text{Minimum number of emitters} = \frac{\text{Minimum Area to be Wetted (sq. ft.)}}{\text{Area Wetted by Emitter (sq. ft.)}}$$

EXAMPLE

The minimum area to be wetted for each 4-foot azalea is 6.3 square feet. This is because the area of the root zone is estimated as:

$.7854 \times \text{diameter} \times \text{diameter}$ or $.7854 \times 4 \times 4 = 12.6$ sq. ft.

The minimum area that should be wetted is 50 percent of the root zone or $1/2 \times 12.6 = 6.3$ sq. ft.

Dividing this by the area wetted by each emitter (1.8 square feet) tells us that we will need at least four emitters for each azalea.

Chapter Review

To check your understanding of the material covered in Chapter 5, complete this review. The review is partly based on the partially completed hydrozone worksheet (Figure 7-1) which is located at the end of Chapter 7.

1. In a densely planted hydrozone, is the base plant the plant material that has the highest or lowest water requirement in the hydrozone?
2. For each emission device, indicate whether it is best suited to water a dense planting scheme or individual plants in a sparse planting scheme:
 - a. Xeri-Bug emitters
 - b. Xeri-Bubblers
 - c. Landscape Dripline tubing
 - d. Lower flow PC-Modules
 - e. Xeri-Sprays
3. For each soil type, indicate the suggested Landscape Dripline inline emitter flow rate and lateral spacing.
 - a. Coarse
 - b. Medium
 - c. Fine
4. The base plant in our sample hydrozone is ice plant, a dense ground cover planted in medium soil. We will use Landscape Dripline with 0.9 GPM emitters to irrigate this plant. Use Table 5-3 to determine the emitter and lateral spacing for the ice plant.
5. Determine the number of Landscape Dripline rows and the space between rows for a planted area 10' wide using the Lateral Line Spacing Worksheet on page 35.



Answer Key Check your answers to the review items with the correct answers below.

1. Lowest
2. a. Sparse
b. Sparse
c. Dense
d. Sparse
e. Dense
3. a. 0.9 GPH/12" spacing
b. 0.9 GPH/18" spacing
c. 0.6 GPH/24" spacing
4. Emitter and lateral spacing = 18 inches
5. Number of rows = 11 rows
Spacing between rows = 11.6 inches

6

CALCULATE SYSTEM RUN TIME

The system run time is determined by the base plant. Since the base plant is the plant that requires the least amount of water, you will run the system only long enough to supply the correct amount of water to the base plant. In the next chapter, you will determine the flow rates for the non-base plants as well as the best-suited emission devices to achieve these flow rates. This will be based on two things: the watering schedule for the base plant and the daily watering requirements of the non-base plants.

This chapter will use the same hydrozone design worksheets introduced in the previous chapters. Refer to the sample worksheet (Figure 7-1) located at the end of Chapter 7, as you read this chapter.

The process of calculating the system run time involves several steps:

1. Calculate the run time per day using a general formula.
2. Determine the maximum system run time. Maximum run time is the length of time the system can run before you begin to waste water due to deep percolation loss below the desired watering depth.
3. Determine the irrigation interval—how often you will run your system.



1. Calculate System Run Time

The general formula for system run time is:

$$\text{Run Time Per Day} = \frac{\text{Water Requirement}}{\text{Flow Rate}}$$

However, since the water requirements are measured differently, you will apply this general formula in slightly different ways for dense and sparse plantings.

Dense Plantings In Chapter 4, you calculated the water requirement for dense plantings in inches per day (also see Appendix B). In order to calculate the system run time, you must also measure the flow in inches per hour. We call this flow measurement “Emitter Discharge Rate,” (EDR). EDR is measured in inches per hour.

The formula for determining EDR is:

$$\text{EDR (inches per hour)} = \frac{231.0 * q}{s * l}$$

where: q = emitter flow rate (gallons per hour)
 s = emitter spacing (inches)
 l = lateral spacing (inches)

Table 6-1 shows the EDR for the most common Landscape Dripline spacing schemes. For other emission devices, calculate EDR using the formula.

TABLE 6-1: EMITTER DISCHARGE RATES (EDR) FOR LANDSCAPE DRIPLINE IN INCHES PER HOUR*			
		Emitter Flow Rate	
Emitter Spacing	Lateral Spacing	0.6 GPH	0.9 GPH
12"	12"	0.96 in./hr.	1.44 in./hr.
18"	18"	0.43 in./hr.	0.64 in./hr.
24"	24"	0.24 in./hr.	0.36 in./hr.
*At 100% Application Efficiency			

Because both the EDR formula and the data in Table 6-1 are based on 100% application efficiency, you must adjust the EDR figure you use for the application efficiency of your system in a particular climate. To do this, multiply the EDR figure from the table and the application efficiency (percentage) that you recorded on your Site Data Worksheet. The result is the “adjusted EDR.”

EXAMPLE

If you are using Landscape Dripline with 0.9 GPH emitters spaced at 18" X 18", the EDR from table 6-1 is 0.64 inches per hour. If the climate is warm humid, the application efficiency will be approximately 90%.

Multiply the EDR (0.64 inches per hour) by the application efficiency expressed as a decimal (0.90). The adjusted EDR is 0.576 or 0.58 inches per hour.



To calculate the system run time for densely planted base plants, use the following variation of the general formula:

$$\text{Run Time Per Day (hours)} = \frac{\text{Water Requirement (inches per day)}}{\text{Adjusted EDR (inches per hour)}}$$

Most irrigation controllers are set in minutes, so you must convert to minutes by multiplying run time (in hours) by 60.

EXAMPLE

You determine that the water requirement for the base plants in your hydrozone is 0.2 inches per day based on the formula in Chapter 4 and Appendix B. The adjusted EDR is 0.58 inches per hour.

Divide the water requirement by the adjusted EDR to determine the system run time. The system run time is 0.34 hours.

Then you multiply the hours by 60 to find the run time in minutes:

$$0.34 \text{ Hours} \times 60 \text{ minutes} = 21 \text{ minutes per day}$$

Sparse Planting In Chapter 4, you calculated the water requirement in gallons per day for sparse plantings. To calculate the system run time for sparse plantings, the formula is:

$$\text{Run Time Per Day (hours)} = \frac{\text{Water Requirement (GPD)}}{\text{Flow (GPH)}}$$

Be sure to total the flows of all emitters used to irrigate a single base plant. Also, since the flow amounts are based on 100% application efficiency, you must adjust the result for the application efficiency of your system. To do this, multiply the total flow and the application efficiency (percentage) that you recorded on your Site Data Worksheet. The result is the “adjusted flow.” Most irrigation controllers are set in minutes, so you must convert to minutes by multiplying Run Time (in hours) by 60.

EXAMPLE

Assume you have determined that the water requirement for your base plant is 1.4 gallons per day. You have selected two single-outlet 2.0-GPH emitters to water each plant. To calculate the system run time, you first calculate the adjusted flow:

$$4.0 \text{ GPH (2 emitters @ 2.0 GPH)} \times .90 = 3.6 \text{ GPH}$$

Then divide the water requirement (1.4 GPD) by adjusted flow (3.6 GPH) and round to two decimal places:

$$1.4 \text{ GPD} \div 3.6 \text{ GPH} = 0.39 \text{ Hours}$$

Then you multiply the hours by 60 to find the run time in minutes:

$$0.39 \text{ Hours} \times 60 \text{ minutes} = 23 \text{ minutes per day}$$



2. Determine Maximum Run Time

The maximum system run time is the length of time the system can run before you begin to waste water due to deep percolation loss below the desired watering depth. To determine the maximum system run time, you must know the flow rates of the emitters and the allowable depletion of the soil.

Allowable depletion is the percentage of soil moisture that you will allow the plants to deplete before watering again. If you select a lower allowable depletion percentage, you initiate a watering cycle when just a small amount of moisture has been depleted. Watering will occur more frequently but for less time at each irrigation cycle. A higher allowable depletion will require fewer irrigations, providing more water at each irrigation. Generally, allowable depletion should not exceed 30-50 percent for a low-volume irrigation system.

Use Tables 6-2 through 6-4 to estimate the maximum run time for your system and make a note of it. Use the table for the soil type in your site. These tables are based on an allowable depletion of 30 percent. For calculations based on other allowable depletion percentages, see Appendix A.

TABLE 6-2: MAXIMUM SYSTEM RUN TIMES FOR COARSE SOIL			
Watering Depth	Emitter Spacing	Emitter Flow (GPH)	Maximum Run Time
3 inches	Use Xeri-Sprays, Xeri-Pops or 1800 Spray Heads		
6 inches			
9 inches			
12 inches	12 inches	0.5 1.0 2.0	37 minutes 18 minutes 9 minutes
18 inches	18 inches	0.5 1.0 2.0	145 minutes 62 minutes 31 minutes
24 inches	24 inches	0.5 1.0 2.0	296 minutes 148 minutes 74 minutes
Available Water = 1.4"/ft.; Application Efficiency = 85%; Allowable Depletion = 30%			



TABLE 6-3: MAXIMUM SYSTEM RUN TIME FOR MEDIUM SOIL

Watering Depth	Emitter Spacing	Emitter Flow (GPH)	Maximum Run Time
3 inches	Use Xeri-Sprays or Xeri-Pops		
6 inches	12 inches	0.5	26 minutes
		1.0	13 minutes
		2.0	7 minutes
9 inches	18 inches	0.5	89 minutes
		1.0	45 minutes
		2.0	22 minutes
12 inches	24 inches	0.5	211 minutes
		1.0	106 minutes
		2.0	53 minutes
18 inches	36 inches	0.5	713 minutes
		1.0	357 minutes
		2.0	178 minutes
24 inches	48 inches	Use individual emitters based on plant needs.	
Available Water = 2.0"/ft.; Application Efficiency = 85%; Allowable Depletion = 30%			

TABLE 6-4: MAXIMUM SYSTEM RUN TIME FOR FINE SOIL

Watering Depth	Emitter Spacing	Emitter Flow (GPH)	Maximum Run Time
3 inches	12 inches	0.5	16 minutes
		1.0	8 minutes
		2.0	4 minutes
6 inches	24 inches	0.5	132 minutes
		1.0	66 minutes
		2.0	33 minutes
9 inches	36 inches	0.5	446 minutes
		1.0	223 minutes
		2.0	111 minutes
12 inches	48 inches	Use individual emitters based on plant needs.	
Available Water = 2.5"/ft.; Application Efficiency = 85%; Allowable Depletion = 30%			



3. Determine Irrigation Interval

The first task in determining the irrigation interval is to compare your calculated system run time per day to the maximum run time.

In most cases the calculated run time per day will be **less** than the maximum run time, and you can use the following formula to determine the maximum irrigation interval:

$$\text{Maximum Irrigation Interval (days)} = \frac{\text{Maximum Run Time}}{\text{Calculated Run Time Per Day}}$$

EXAMPLE:

You are irrigating to a depth of 18 inches in coarse soil with 1.0 GPH emitters. The calculated run time per day is 19 minutes. The maximum run time is 62 minutes. Using the formula, you determine that the maximum irrigation interval should be 3.26 days. You round this down to the nearest day, and irrigate at least every third day.

You now have all the information you need to decide your irrigation schedule for this hydrozone. If you water daily, you will run your system for 19 minutes. Or you might choose to water every other day for 38 minutes (2 × 19). If you choose to water on the maximum interval of three days, you must water for 57 minutes (3 × 19). To avoid runoff, split this longer watering time into multiple cycles.

If the calculated run time is **more** than the maximum run time, you will need to run your system more than once each day. Depending on the capability of your controller and how much more time you need, you can determine how many times to run the system each day to provide adequate water without wasting any due to deep percolation. In general, you should probably be able to irrigate just twice each day in these cases.

EXAMPLE:

You are irrigating to a depth of 9 inches with 1 GPH emitters in medium soil. Your calculated run time is 66 minutes per day. The maximum run time (from Table 6-3) is 45 minutes. You must irrigate twice each day for 33 minutes each time to total the required 66 minutes.



Chapter Review

To check your understanding of the material covered in Chapter 6, complete this review. The review is based on the partially completed hydrozone worksheet (Figure 7-1) which is located at the end of Chapter 7.

1. We have determined that we will use Landscape Dripline with 0.6 GPH emitters spaced at 12" to irrigate the base plant in hydrozone 7. Use Table 6-1 to determine the EDR.
2. Calculate the Adjusted EDR by multiplying the EDR by the application efficiency.
3. Calculate the system run time in minutes for this hydrozone.
4. Use the tables to determine the maximum run time for this hydrozone.
5. Determine the maximum irrigation interval for this hydrozone.
6. If we choose to irrigate once every two days, how long will each irrigation cycle be?



Answer Key

Check your answers to the review items with the correct answers below.

1. EDR = 0.96
2. Adjusted EDR = $0.888 \times .90 = 0.86$ inches per day
3. System Run Time = 4.2 minutes per day
4. Maximum Run Time = approximately 26 minutes.
5. Maximum Irrigation Interval = 6 days
6. Irrigation cycle: 8.4 minutes (2 x 15)

7

IRRIGATE NON-BASE PLANTS

In earlier chapters, you determined the base plant for your hydrozone: the plant with the smallest daily water requirement. You then selected emission devices to irrigate the base plant and calculated the system run time based on the emission devices you chose.

In this chapter, you will select emission devices for the non-base plants in the hydrozone. Because you've already determined the system run time, you will need to take this into account in determining the flow, type and quantity of emission devices to use for each non-base plant.

To calculate the number of emission devices required for each non-base plant, you must determine the minimum flow rate required to irrigate the plant in the time allotted.

Divide the daily water requirement for each remaining plant by the system run time you have already calculated (for your base plant). This result tells you the minimum flow rate required for each plant.

EXAMPLE

You have determined that the system run time will be 0.2 hour. Your hydrozone includes a crepe myrtle tree with a daily requirement of 3.3 GPD. You can calculate the minimum flow rate required for the crepe myrtle by dividing:

$$3.3 \text{ GPD} \div 0.2 \text{ hour} = 16.5 \text{ Gallons per Hour}$$

Next, select emission devices for each plant so that the total flow rate meets or exceeds your calculated flow rate. Avoid using two emission devices with different flow rates for the same plant. Use Table 7-1 as a guide.

TABLE 7-1: EMISSION DEVICE FLOW RATES

Emission Device	Available Flow Rates
Xeri-Bug Single Outlet Pressure Compensating Emitter	0.5, 1.0, 2.0 GPH
Shrub Xeri-Bug Single Outlet Pressure Compensating Emitter	1.0, 2.0 GPH
Pressure Compensating Modules	5.0, 7.0, 10.0, 12.0, 18.0, 24.0 GPH
Multi-Outlet Xeri-Bug; Multi-Outlet Shrub Xeri-Bug	1.0 GPH per outlet (up to 6 outlets)
Xeri-Bubblers	Streams: 0-13.0 GPH, Umbrella: 0-35.0 GPH
Xeri-Sprays	0-31.0 GPH
Landscape Dripline	0.6, 0.9 GPH
Xeri-Pops w/ Multi-Port Nozzle	10.5, 21.0, 31.5, 42.0 GPH
Xeri-Pops w/ PCS Screens and choice of MPR Nozzle	0.1, 0.2, 0.3, 0.4, 0.6 GPM

EXAMPLE

Referring to Table 7-1, you select four 5.0 GPH Pressure-Compensating Modules to water the crepe myrtle. These four devices will provide a combined flow of 20.0 GPH, which is somewhat more than the calculated flow of 16.5 GPH. The preferred use of four emission devices versus one or two flow devices will be explained in the next chapter.

It is important to consider the soil type and how best to avoid potential runoff in clay-like soils. It may be best to create some type of reservoir at the base of plants to capture the water from higher flow emission devices, such as the PC-10, 10 GPH Pressure Compensating Module.

Complete this process of calculating flow rates and selecting emission devices for each non-base plant. Refer to chapter 5 as well as subsequent chapters for information about placement of the emission devices.

Chapter Review

To check your understanding of the material covered in Chapter 7, complete this review. The review is based on the partially completed hydrozone worksheet (Figure 7-1) which is located on the next page.

1. Calculate the total flow needed to irrigate each of the ferns within the system run time.
2. We have determined that Xeri-Bubblers set for an umbrella pattern are the most effective way to irrigate the ferns. If we use two Xeri-Bubblers for each fern, what should the flow for each bubbler be?

LOW-VOLUME DESIGN WORKSHEET: DENSE HYDROZONE

DATE _____
JOB NUMBER _____

1 Site Information

Name John & Wendy Doyle

Address 7836 Connor Lane

City Brighton State CA zip 92867

Contact John

Day Phone 714-555-8136 Eve. Phone 714-555-1089

Daily PET (inches per day) 0.20

Application Efficiency 90%

Soil Type: Coarse
 Medium
 Fine

Planting Scheme

Ground Cover Only

Ground Cover/Trees

Ground Cover /Shrubs

Ground Cover/Shrubs/Trees

Shrubs/Trees

Shrubs Only

Base Plant

Ground Cover

Shrubs

4 Watering Depth

3" 18"

6" 24"

9" 36"

12"

Emitter Spacing

12"

18"

24"

36"

1 HYDROZONE

7

DESCRIPTION

Mixed G. C. & shrubs

5 SYSTEM RUN TIME

Base Plant

2 BASE PLANT SPECIES	SPECIES FACTOR	DENSITY FACTOR	MICROCLIMATE FACTOR	K _c	3 WATER REQUIREMENT	4 EMITTER FLOW RATE	5 ADJUSTED EDR
Ice Plant	low	high	high				

Plant Canopy Area

0.7854 × Diameter × Diameter = Square Feet

Water Requirement

K_c × PET = Inches per Day

Water Requirement

.623 × Area × K_c × PET
Application Efficiency = Gallons per Day (GPD)

Non-Base Plants

2 ADDITIONAL PLANT SPECIES	SPECIES FACTOR			DENSITY FACTOR			MICROCLIMATE FACTOR			K _c	3 PLANT DIAMETER (FT.)			6 EMISSION DEVICES		
											PLANT DIAMETER (FT.)	CANOPY AREA (SQ. FT.)	WATER REQUIREMENT (GPD)	TYPE	FLOW	QUANTITY
Azaleas (2)	avg.	0.5	low	0.5	high	1.3	0.3	4.0	12.6	0.5	P.C. Mod.	7.0	2 per			
Privet (12)	avg.	0.5	med.	1.0	high	1.3	0.7	3.0	7.1	0.7	P.C. Mod.	10.0	2 per			
Hawthorne (6)	avg.	0.5	med.	1.0	high	1.3	0.7	3.0	7.1	0.7	P.C. Mod.	10.0	2 per			
Ferns (2)	high		low		high			5.0			Xeri-Bubbler		2 per			

Figure 7-1: Dense Hydrozone Design Worksheet



Answer Key Check your answers to the review items with the correct answers below.

1. Total flow = 20 GPH
2. Emitter flow = 10 GPH

8

SYSTEM LAYOUT

System layout for low-volume hydrozones is relatively easy. Once you have determined the type, number and spacing of emission devices required for each plant or group of plants, simply determine the most cost-effective way to connect the various emission devices to the water source. However, you must also be certain not to exceed the hydraulic constraints of the system components. (See Chapter 9 for information on hydraulics.)

Figure 8-1 shows a typical hydrozone layout, including the placement of emission devices around each plant in the hydrozone.

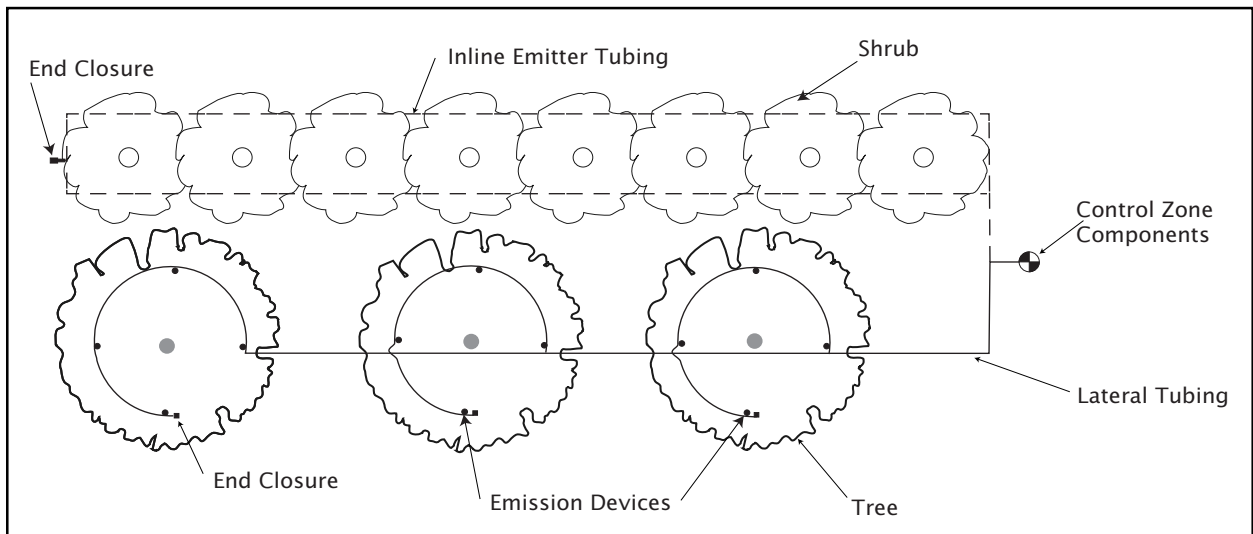

Figure 8-1: Correct placement of emitters

Figure 8-2 shows several options for individual plants that require multiple emission devices, including a single loop of tubing, rigid PVC pipe and a multi-outlet emitter with 1/4" distribution tubing.

Figures 8-3 and 8-4 show typical layouts using poly drip tubing (Landscape Dripline) and Rigid PVC tubing.

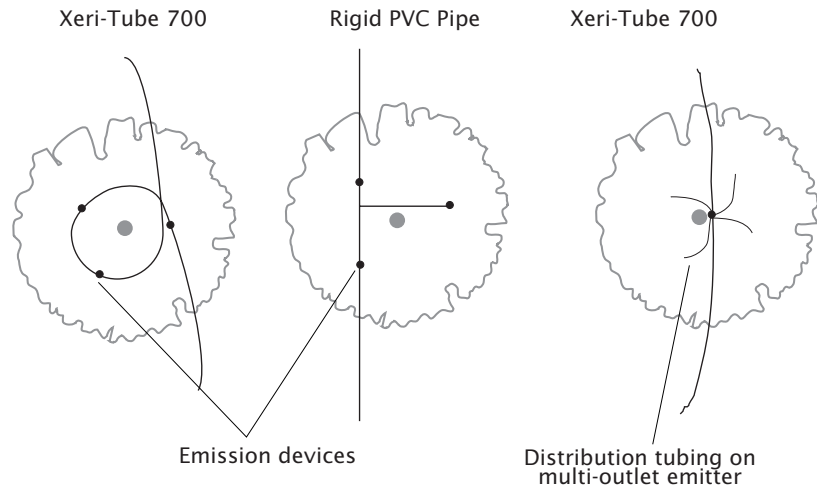

Figure 8-2: Emitter layout options

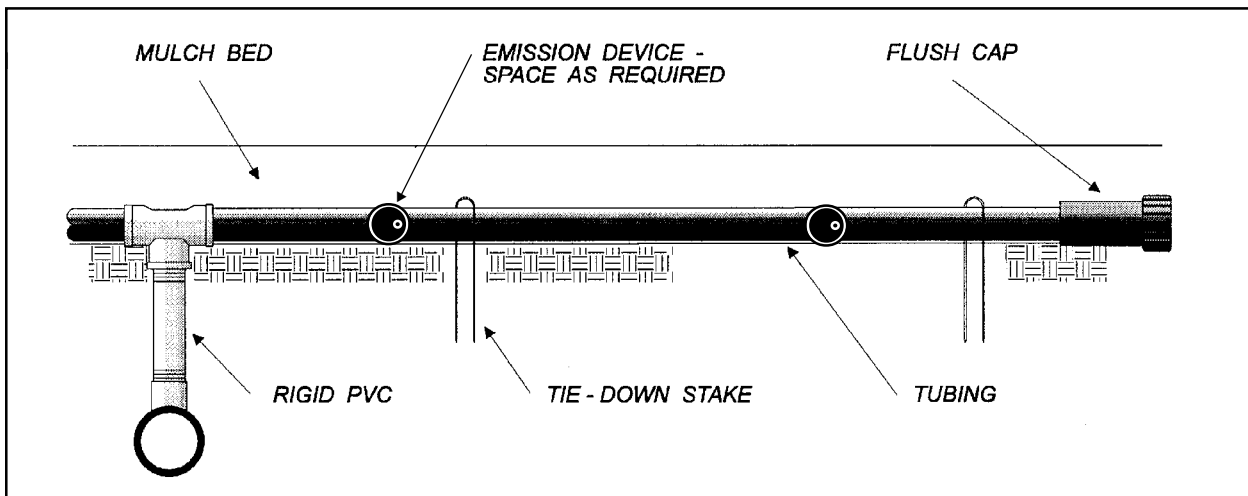

Figure 8-3: Layout using poly drip tubing (Xeri-Tube 700)

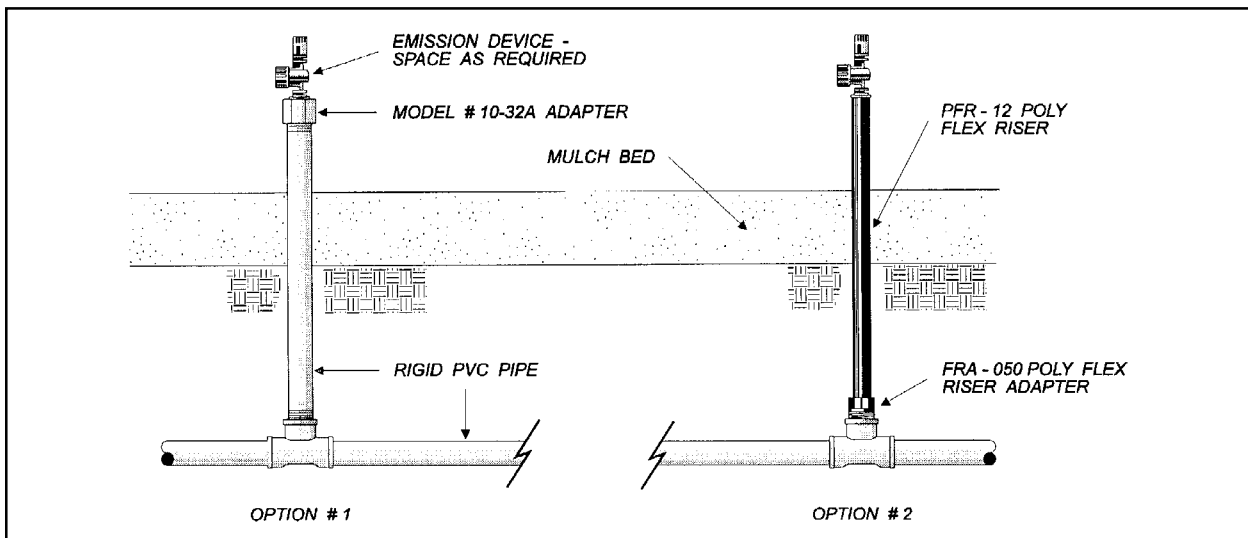

Figure 8-4: Layout using rigid PVC

Using Inline Tubing

When using Landscape Dripline, remember that the spacing of the emitters is determined primarily by the soil type. To maximize water savings and prevent water waste below the root zone, consider the area of the root zone as well as the recommended watering depth. Lay out the rows so the emitters themselves form a triangular or square pattern.

When possible, lay out the inline tubing so that it forms a loop, with water flowing in two directions from the water source. This helps eliminate the build up of contaminants in one specific area of the tubing. This looping technique also assures continuous watering to the entire planting area should the tubing become damaged in one specific area.

If your tubing is configured in a loop, place end closures at the end of long runs and at any dead-end locations throughout the zone. The end closures should be placed to allow easy access. A complete, manual flushing of the zone should be done at start-up and during winterization in freezing climates.

Placing Supplemental Emitters

Occasionally, plants within the Landscape Dripline watering grid require supplemental irrigation. When Xeri-Bug emitters are added to the grid, the additional flow must also be added. For example, if 5 GPH of flow is added to the grid, the maximum length of the laterals must be reduced by 5 GPH plus a safety factor of 20 percent (1 GPH in this example) for a total flow adjustment to 6 GPH. See Figures 8-5 and 8-6 and the following example:

EXAMPLE

1. Divide the adjusted flow by the flow rate of the Landscape Dripline emitter to determine how many inline emitters it takes to equal this adjusted flow:

$$\frac{6 \text{ GPH (adjusted flow)}}{0.9 \text{ GPH (emitter flow rate)}} = 6.7 \text{ or } 7 \text{ emitters}$$

2. Multiply the number of emitters by the spacing of the Landscape Dripline being used:

$$7 \text{ emitters} \times 12" \text{ emitter spacing} = 84" \text{ length of tubing}$$

3. To convert inches into feet:

$$84" \div 12" = 7'$$

4. Adjust the possible maximum lateral length by 7'. From Figure 12, at 45 PSI, the maximum lateral length for 0.9 GPH and 12" emitter spacing is 236'. To get the adjusted maximum length of tubing:

$$236' - 7' = 229'$$

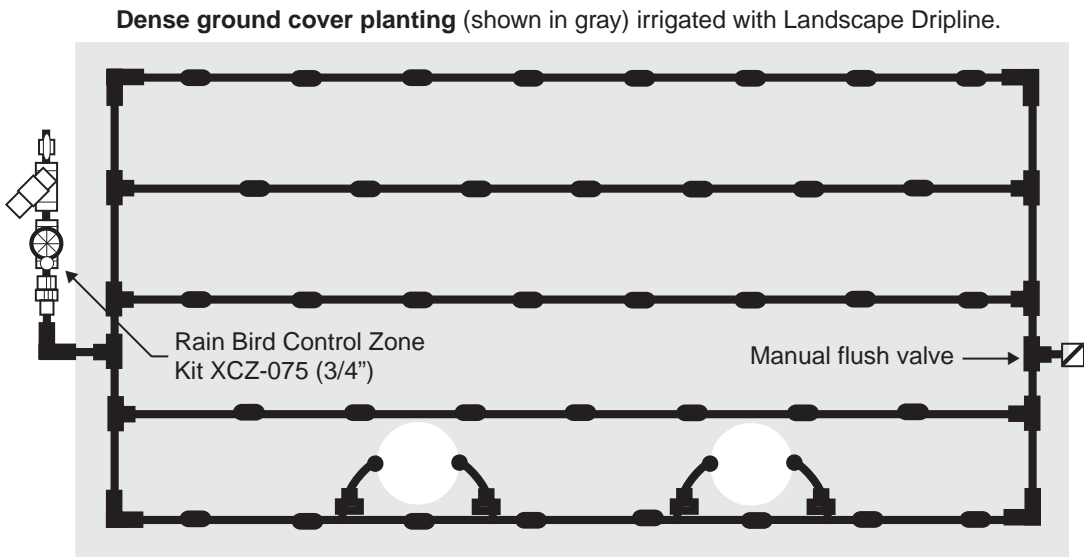

Sparse shrub planting (shown in white) irrigated with supplemental single-outlet emitters connected to Rain Bird Landscape Dripline tubing. Emitters use Rain Bird 1/4" distribution tubing, TS-025 stakes and DBC-025 bug caps.

Figure 8-5: Placement of supplemental emitters for shrubs or trees: top view

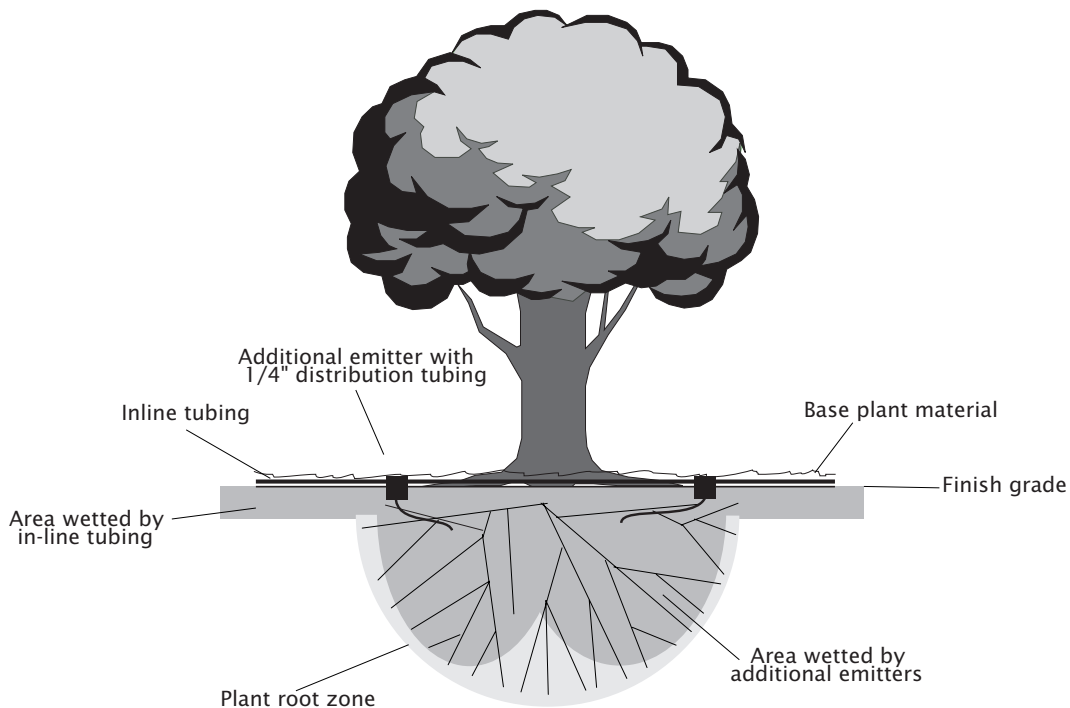

Figure 8-6: Placement of supplemental emitters for shrubs or trees: section view



System Configuration

Filtration When a significant distance exists between the system's primary filter and the Landscape Dripline grid, Rain Bird's Control Zone Kit should be installed. The Control Zone Kit filter acts as a secondary filter to protect the Landscape Dripline grid against contamination that could be caused by a break in the sub-main. The kit consists of a ball valve, 200-mesh Y-filter, remote control valve (or anti-siphon valve), 3/4" pressure regulator and Schedule 80 close nipples.

Pressure Regulation Landscape Dripline should have an operating pressure of no more than 60 PSI (4 Bars). If static pressure is higher than 60 PSI (4 Bars) at the start of the Landscape Dripline run, pressure regulation is required. When this is the case, use compression fittings or make sure to clamp your insert fittings. Pressure regulators should be installed as close to the planting area as possible to assure that the desired pressure is available to the Landscape Dripline watering zone.

Use Insert or Compression Fittings Choose either Rain Bird LD16 Series insert fittings or Rain Bird 600CF Series compression fittings when installing and connecting Rain Bird's Landscape Dripline. While insert fittings are designed to be used up to 45 PSI (3 Bars) without clamps, compression fittings can be used up to 60 PSI (4 Bars) without the need for any clamps. They are recommended for hot weather climates to provide maximum retention strength.

Stakes and Staples Landscape Dripline requires the use of stakes or staples to install it securely to the ground. Use Table 8-1 as a guide for staking:

TABLE 8-1: SPACING OF STAKES AND STAPLES		
Soil Type	Stake Spacing	Additional Stakes
Fine	4'-6' (1,2-1,8 m)	Before and after every turn
Medium	3'-5' (0,9-1,5 m)	Before and after every turn
Coarse	2'-3' (0,6-0,9 m)	Before and after every turn

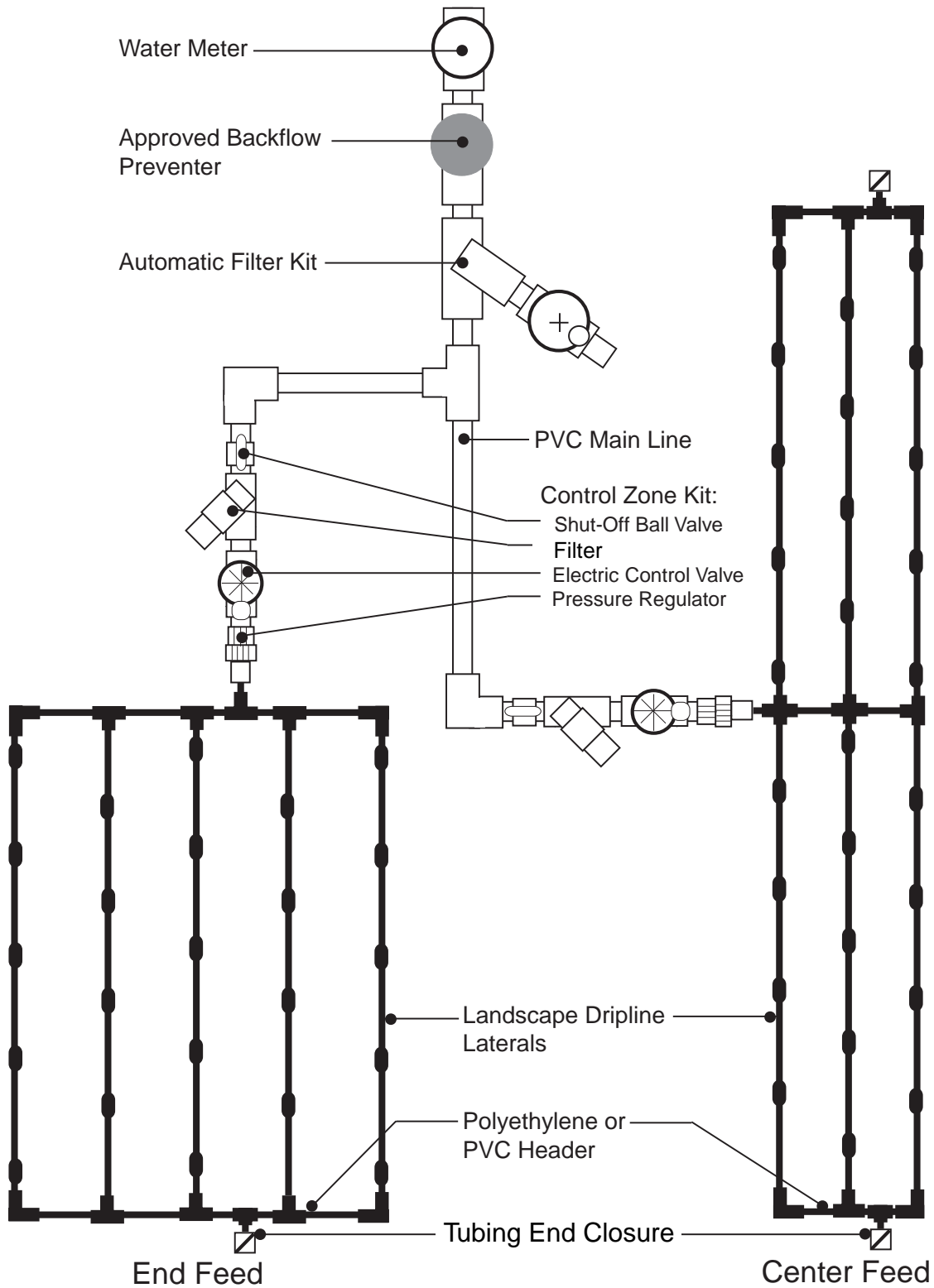

Figure 8-7: Landscape Dripline system configuration

Irrigating Slopes

On a slope, without correct emitter placement, water will percolate downhill and out of the root zone. When installing emitters on a slope, place them above the plants so that the wetting pattern remains within the root zone. Figures 8-8 and 8-9 illustrate the correct placement of emitters and lateral pipes on a slope.

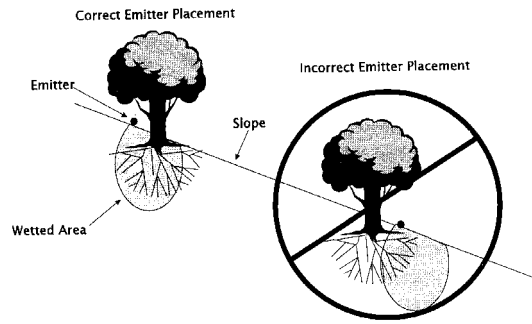

Figure 8-8: Correct emitter placement on slope

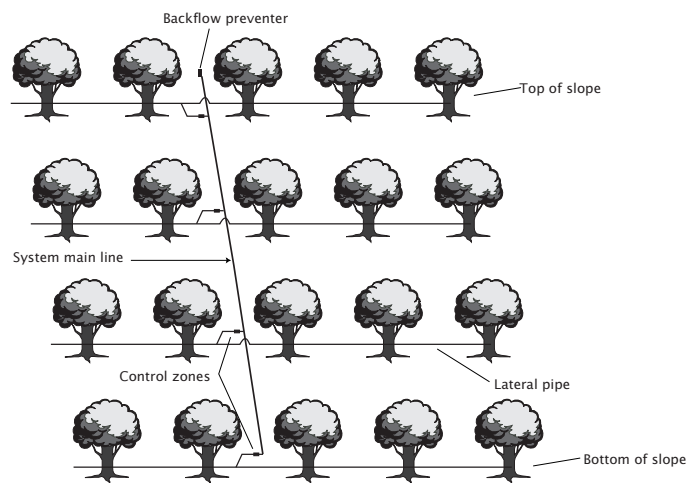

Figure 8-9: Correct placement of lateral pipe on slope

When installing Landscape Dripline on a slope, laterals should follow the contours of the slope. Space rows normally at the top two-thirds and gradually increase the spacing up to 25 percent as you approach the bottom one-third (see Figure 8-10). When elevation change is 10' (3 m) or more, zone the bottom one-third of the slope separately from the rest to provide greater control. Subsurface applications of Landscape Dripline should always have an air relief valve installed perpendicular to the Landscape Dripline grid and at its highest point.

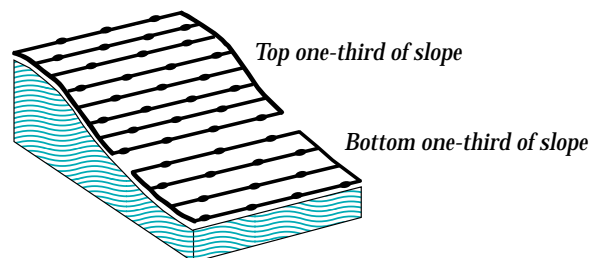

Figure 8-10: Placement of Landscape Dripline on a slope

Container Plants

Low-volume irrigation can also be used to water container plants. Run the 1/4" distribution tubing up through the bottom of the container whenever possible and attach either emitters or micro-bubblers to automatically apply exactly the right amount of water. Be careful not to pinch the tubing closed. Figures 8-11 and 8-12 illustrate two possible applications.

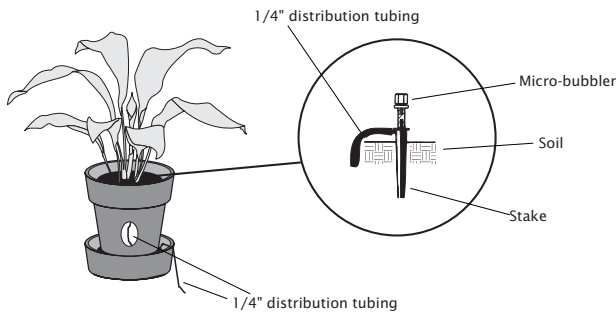

Figure 8-11: Micro-bubbler in a container plant

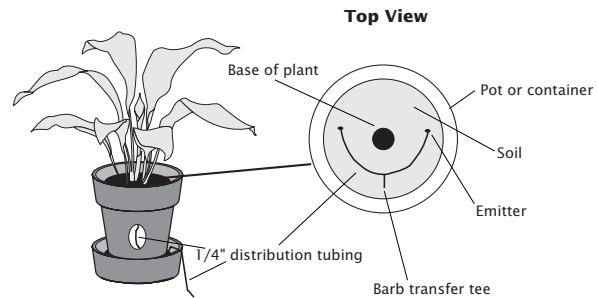

Figure 8-12: Multiple emitters in a container plant

Low-volume irrigation can be easily adapted for hanging plants as well (Figure 8-13). Lateral tubing (1/2") can be run along a beam or arbor. Place emission device(s) above each plant, and run 1/4" distribution tubing from the emission device down into the plant container. Attach the tubing to a small stake, and add a diffuser bug cap to prevent insects or debris from clogging the tube.

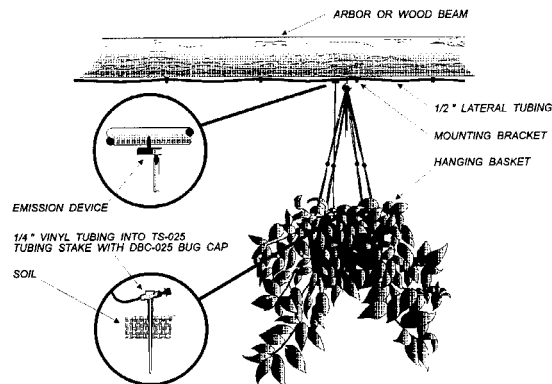

Figure 8-13: Xeri-Bug emitter in a hanging basket

If the total flow required by the hanging plants is less than 40 GPH and the available pressure is at least 30 PSI, use 1/4" distribution tubing in place of the 1/2" tubing that is run along the beam or arbor. Use an SPB-025 connector or standard 1/4" barb connector as a take-off barb to deliver water from a 1/2" poly drip tubing lateral located on the ground, to the 1/4" tubing that will run up to the hanging baskets. Use one to two low-flow, pressure-compensating emitters such as XB-05 and XB-10 at the end of the 1/4" tubing and secure inside the basket with a tubing stake.

9

SYSTEM HYDRAULICS

Chapter 3 covered gathering site data and Chapters 4 - 8 described how to design and lay out your low-volume irrigation system. This chapter covers system hydraulics, the final step in the design process.

The main goal of determining system hydraulics is to assure that there is sufficient flow and water pressure available to irrigate all parts of the landscape. The water pressure at various points in the irrigation system is influenced by changes in elevation and by loss of pressure due to friction between water and the system components.

This chapter is not intended to be a complete course in irrigation system hydraulics. If you need basic training in hydraulics, we recommend that you obtain Rain Bird's *Landscape Irrigation Design Manual* (P/N D38470A). Contact your local Rain Bird distributor or Rain Bird representative about ordering this training material.

Water Pressure

Water pressure is defined as the force exerted by water over a given area. Water pressure is most often measured in pounds (force) per square inch (area), abbreviated PSI.

Static Pressure Static pressure is the pressure of water in a completely closed system, such as a main line with all of its outlet valves turned off. The static water pressure at the water source (usually the water meter or pump outlet) is the starting point for your hydraulic design. It indicates the potential pressure that is available to operate your irrigation system.

You should determine the static pressure at the water source as you collect site data. For more information on collecting site data, see Chapter 3.

Dynamic Pressure Dynamic pressure is the water pressure at any point in the system at a given flow. Dynamic pressure will vary throughout the system due to friction loss and elevation changes.

Friction Loss

Friction loss is a pressure loss caused by water flowing through the system. This loss occurs in every component of the system through which water flows. Pipes, valves, water meters, backflow preventers and pipe fittings all provide some resistance to the water flowing through them, creating a pressure loss. The roughness on the inside surfaces of these components creates a drag on the flowing water causing turbulence, which reduces pressure. The shape of each component, or changes in flow direction (such as within a valve) add to the pressure loss.

Elevation Changes

Changes in elevation also cause changes in water pressure. Each foot of elevation change means a change in pressure of .433 PSI. That is, it takes .433 PSI to move water *up* one foot. And if water flows *down* one foot, there will be a pressure gain of .433 PSI. Obviously, significant changes in elevation within your irrigation site can have a major impact on the pressure in the system.

In Figure 9-1, the distance from the water's surface to ground level is 160 feet. To find the static pressure at ground level, you would multiply .433 by 160 to get 69.28 PSI.

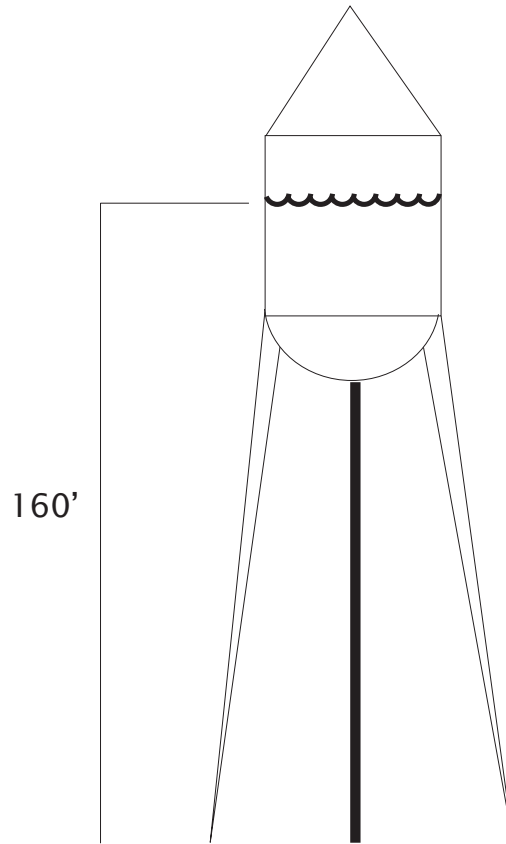

Figure 9-1: Determining static pressure based on elevation

Calculating Pressure Loss

Flow To calculate pressure losses, you need to know the total flow required by the hydrozone (in GPH or GPM). As a general rule for low-volume systems, you should design the system so that you have a pressure of at least 30 PSI at the inlet to each lateral pipe. As a conservative rule of thumb, flow rates through each lateral pipe should not exceed 4.7 GPM (282 GPH). In addition, for ease of maintenance and hydraulic functionality, individual, continuous runs of 1/2" lateral poly drip tubing in one direction should not exceed 500 feet.



Sparsely Planted Hydrozones

In a sparsely planted hydrozone, where you have used individual emitters or micro-bubblers to irrigate plants, you'll need to add up the total flow required by all the emission devices in the hydrozone.

You may want to use a worksheet similar to the one below (Figure 9-2) to calculate the total flow in a sparsely planted hydrozone.

This approach can be used for each hydrozone or for the entire planting area so that hydrozones can be determined based on flow rates and microclimate considerations.

TOTAL FLOW WORKSHEET		
Number of Emitters/PC Modules or Micro-Bubblers	Emission Device Flow Rate	Flow (GPH)
x	0.5 GPH	=
x	1.0 GPH	=
x	2.0 GPH	=
x	5.0 GPH	=
x	7.0 GPH	=
x	10.0 GPH	=
x	13.0 GPH	=
x	35.0 GPH	=
x		=
x		=
TOTAL FLOW (GPH):		*
Convert GPH to GPM by dividing GPH by 60:		**
<p><i>*Should not exceed 282 GPH per lateral pipe</i> <i>**Should not exceed 4.7 GPM per lateral pipe</i></p>		

Figure 9-2: Total flow worksheet

EXAMPLE

Assume that you have a sparsely planted hydrozone with mixed types of shrubs and one large tree. Each of the shrubs require two emitters, either 1/2 or 1 GPH. The large tree requires four 10-GPH emitters. The worksheet for this hydrozone might look like the sample below.

COMPLETED TOTAL FLOW WORKSHEET		
Number of Emission Devices	Emission Device Flow Rate	Flow (GPH)
20	x 0.5 GPH =	10.0
34	x 1.0 GPH =	34.0
	x 2.0 GPH =	
	x 5.0 GPH =	
	x 7.0 GPH =	
4	x 10.0 GPH =	40.0
	x 13.0 GPH =	
	x 35.0 GPH =	
	x =	
	x =	
	x =	
TOTAL FLOW (GPH):		* 84.0
Convert GPH to GPM by dividing GPH by 60:		** 1.4
*Should be less than 282 GPH per lateral pipe **Should be less than 4.7 GPM per lateral pipe		

Figure 9-3: Completed total flow worksheet



Densely Planted Hydrozones

In a densely planted area where you have designed a Landscape Dripline grid, use the Flow Rate Worksheet below to determine the total flow through your grid. If you have any supplemental emitters, be sure to add in their adjusted flows as well. For this example, we will assume coarse soil and will therefore specify Landscape Dripline model LD-09-12-500 (0.9 GPH, 12" spacing, 500' coil).

FLOW RATE WORKSHEET			
Follow the example below to determine the flow rate:			
To Get This:	Do This:	Calculations	Totals
1. Length of tubing in feet:	Determine the total length in feet from grid		2,000 feet
2. Length of tubing in inches:	Multiply feet by 12 to get inches	$2,000' \times 12" =$	24,000 inches
3. No. of emitters in the zone:	Divide length by emitter spacing (12", 18", 24")	$24,000" \div 12" =$	2,000 emitters
4. Total no. of emitters:	Round up to next whole number	$2,000 =$	2,000 emitters
5. Flow rate in GPH:	Multiply no. of emitters by flow rate (0.6 or 0.9 GPH)	$2,000 \times 0.9 =$	1,800 GPH
6. Flow rate in GPM:	Divide GPH by 60 to get gallons per minute	$1,800 \div 60 =$	30 GPM
Use the worksheet below to determine the flow rate for your system:			
To Get This:	Do This:	Calculations	Totals
1. Length of tubing in feet:	Determine the total length in feet from grid		
2. Length of tubing in inches:	Multiply feet by 12 to get inches		
3. No. of emitters in the zone:	Divide length by emitter spacing (12", 18", 24")		
4. Total no. of emitters:	Round up to next whole number		
5. Flow rate in GPH:	Multiply no. of emitters by flow rate (0.6 or 0.9 GPH)		
6. Flow rate in GPM:	Divide GPH by 60 to get gallons per minute		

Figure 9-4: Flow rate worksheet

Once you know the total flow of your grid (30 GPM in this example), use Table 9-1 below to determine the number of zones and their respective sizes.

TABLE 9-1: MAXIMUM FLOW RATES					
Sch. 40 PVC Header Size	Max. Flow* GPM	PSI Loss**	Poly Pipe Header Size	Max. Flow* GPM	PSI Loss**
1/2"	4.7 GPM	7.7 PSI	1/2"	4.7 GPM	8.8 PSI
3/4"	8.3 GPM	5.6 PSI	3/4"	8.3 GPM	6.3 PSI
1"	13.5 GPM	4.2 PSI	1"	13.5 GPM	4.8 PSI
1-1/2"	33.9 GPM	2.9 PSI	1-1/2"	33.9 GPM	2.9 PSI
2"	52.4 GPM	1.9 PSI	2"	52.4 GPM	2.2 PSI



Determine Maximum Lateral Lengths

The maximum length of a Landscape Dripline lateral is determined by the maximum allowable pressure loss. The minimum inlet pressure should be 15 PSI. As long as you meet this requirement, there is no need to calculate friction loss in the Landscape Dripline lateral lines. Simply use Table 9-2 to determine the maximum lateral lengths.

TABLE 9-2: MAXIMUM LATERAL LENGTHS						
Inlet Pressure	Maximum Lateral Length (Feet)					
PSI	12" Spacing		18" Spacing		24" spacing	
15	159	130	222	174	283	214
25	252	171	359	231	457	287
35	304	211	435	289	558	358
45	342	236	489	322	627	399
60	392	268	558	365	716	453
Nominal Flow (GPH)	0.6	0.9	0.6	0.9	0.6	0.9
<i>Note: Data assumes a minimum 8.5 PSI at end of lateral for flushing purposes.</i>						
Inlet Pressure	Maximum Lateral Length (Meters)					
BARS	30,5 cm		45,7 cm		61,0 cm	
1,0	48,5	39,6	67,7	53,0	86,3	65,2
1,7	76,8	52,1	109,4	70,4	139,3	87,5
2,4	92,7	64,3	132,6	88,1	170,1	109,1
3,1	104,2	71,9	149,0	98,1	191,1	121,6
4,1	119,5	81,7	170,1	111,0	218,2	138,1
Nominal Flow (l/h)	2,3	3,5	2,3	3,5	2,3	3,5
<i>Note: Data assumes a minimum 8.5 PSI at end of lateral for flushing purposes.</i>						

EXAMPLE

A change in elevation in the hydrozone will affect the maximum distance the Landscape Dripline tubing can be run. Remember: 1 foot of elevation = .433 PSI. To determine exactly how much shorter (uphill) or longer (downhill) the maximum lateral length can be due to a change in elevation, first calculate the pressure loss (PSI) per foot of LD tubing on ground of zero slope.

Example: If the pressure at the start of your Landscape Dripline lateral is 45 PSI and the flow rate is 0.9 GPH with emitters spaced at 12", the maximum distance the tubing can be run without supplemental emitters is 236'. Since the data assumes a minimum 8.5 PSI at the end of the lateral, the total pressure loss for this distance is: 45 PSI - 8.5 PSI = 36.5 PSI.

Now divide this pressure loss by the maximum lateral length: $36.5 \text{ PSI} / 236' = 0.155 \text{ PSI loss per foot of LD tubing lateral}$. We will use this answer later to determine how much shorter or longer the lateral can be due to slope considerations.



When supplemental emitters are added to the grid, the additional flow affects the maximum length of the lateral lines and should be taken into consideration. See Chapter 8, “Placing Supplemental Emitters.”

Maximum Flows and Tubing Runs

When using thick-walled XT-700 poly drip tubing and emission devices such as emitters, PC Modules, Xeri-Bubblers, Xeri-Sprays and Xeri-Pops, you’ll need to check your planned total flow rate and expected tubing runs with the recommended maximum lateral lengths shown in Table 9-3.

TABLE 9-3: MAXIMUM LATERAL LENGTH XT-700				
Flow (GPM)	Flow (GPH)	at 35 PSI Loss	at 25 PSI Loss	at 5 PSI Loss
4.12	249	370'	264'	158'
4.00	240	390'	279'	167'
3.50	210	500'	358'	215'
3.00	180	665'	477'	286'
2.50	150	936'	668'	401'
2.00	120	1,415'	1,012'	607'
1.50	90	2,410'	1,724'	1,034'
1.00	60	5,070'	3,623'	2,173'
0.50	30	18,420'	13,157'	7,894'

* Flows shown assume no barb factor loss and no elevation changes.

** It's important to assure the availability of at least 15 PSI pressure at the end of the tubing run. One reason is because the most commonly used emission device, the Xeri-Bug emitter, has an operating pressure range of 15-50 PSI. When the operating pressure is outside this range, the Xeri-Bug flow rates will be affected. In addition, the 15 PSI at the end of the tubing run will assure sufficient water velocity for proper flushing action.

Pressure Loss Calculation

You calculate the pressure loss in a low-volume system in much the same way you would in a standard sprinkler system. In fact, the pressure-loss calculations for mainline pipe (from the water source to the hydrozone) are identical. Appendix C of this manual contains friction loss and performance data that can help you calculate pressure loss for PVC pipe. You will also need to account for fittings and elevation changes. For more information about calculating pressure losses in irrigation systems, see the *Rain Bird Irrigation Design Manual* (P/N D38470A).

Valve Pressure Loss

Table 9-4 contains pressure loss data for valves typically used in low-volume systems: the Rain Bird Xerigation Control Zones (XCZ-075, XACZ-075, XCZ-100 and XCZ-100COM), the Rain Bird 3/4" DV valve (75-DVX), the 1" DV valve (100-DV) and the 1" PEB valve (100-PEB). You can find additional information about these valves in the Rain Bird Landscape Irrigation Products Catalog or at <http://www.rainbird.com>.

TABLE 9-4: MINIMUM/MAXIMUM FLOWS FOR PROPER VALVE PERFORMANCE

Flow GPM	GPH	XACZ-075 PSI	XCZ-075 PSI	75-DVX PSI	XCZ-100 PSI	100-PEB* PSI
1	60	5.1	3.5	2.5	1.0	3.0
3	180	5.1	3.5	2.5	1.0	2.6
5	300	5.4	3.6	2.9	1.2	2.0
10*	600	9.9	7.5	3.8	5.1	1.5
15*	900	15.9	12.7	4.2	8.8	2.0
20*	1200	24.2	20.2	5.1	14.3	2.5
XCZ-075 pressure loss data above 5 GPM is with PSI-M30X pressure regulator.						
Maximum flow rate with "M" style regulators is 22 GPM.						
* For flows below 3 GPM, always use RBY Series 200 mesh filter installed upstream of valve.						
** For flows greater than 5 GPM, substitute PSI-L30X with a PSI-M30X pressure regulator.						
*** Minimum flow rate of 100-PEB valve is 0.25 GPM without the use of an upstream filter						

Flow Compatibility

It is important to note that all electric control valves have a minimum flow specification that can be found in the valve manufacturer's catalog. For Rain Bird, these minimum flow rates are listed in Table 9-5. If the flow in a drip hydrozone falls below the valve's minimum flow specification and this goes unchecked, trouble can occur. Water weepage from the valve or a valve that just won't shut off electrically are two of the more common problems that occur, especially in drip retrofit situations.

One way to avoid this low flow valve problem is to use one of Rain Bird's Xerigation Control Zones. These control zones put a 200-mesh filter immediately upstream of the electric control valve and thereby deliver a minimum flow specification of 0.2 GPM or 12 GPH. The drip filter is pressure-rated to 150 PSI so it performs reliably upstream of the valve, under constant pressure. Rain Bird also offers the 100-PEB valve, which has a very low minimum flow specification of 0.25 GPM.

TABLE 9-5: MINIMUM FLOW REQUIREMENT FOR PROPER VALVE PERFORMANCE*

Valve Series	DV (3/4", 1")	ASVF (3/4", 1")	PGA (1")	PEB (1")	GB (1")	EFB-CP (1")
Minimum Flow	3 GPM	3 GPM	2 GPM	0.25 GPM	5 GPM	5 GPM
* Assumes no filtration is provided upstream of the valve as described in Table 9-4.						

Lateral Pipe/Tubing

In low-volume systems, 1/2" distribution tubing is typically used for lateral piping. You calculate the pressure loss in this tubing in the same way you do for PVC pipe. Table 9-6 provides friction loss characteristics for XT-700, Rain Bird's thick-walled, heavy-duty 1/2" polyethylene tubing.

TABLE 9-6: FRICTION LOSS CHARACTERISTICS OF XERI-TUBE 700

PSI LOSS PER 100 FEET OF TUBE (PSI/100FT) C = 140 Outside Diameter = 0.700" Inside Diameter = 0.580"		
Flow (GPM)*	Velocity (FPS)	PSI Loss**
0.5	0.61	0.19
1.0	1.21	0.69
1.5	1.82	1.45
2.0	2.43	2.47
2.5	3.03	3.74
3.0	3.64	5.24
3.5	4.24	6.97
4.0	4.85	8.93

*Flows greater than 4.1 GPM (5 FPS) are **not** recommended.
**Does not include pressure loss due to emitter barbs.

High Pressure

While Landscape Dripline is pressure rated to 60 PSI, most other Xerigation components are designed to function at pressures of 50 PSI or less. If the static pressure at the water source is 50 PSI or greater, plan to include an inline pressure regulator in your Xerigation control zone.

Like the valve, pressure regulators need to be matched to the flow rate. Remember to check the flow rate specification for your pressure regulator. Using a regulator rated for the 2-22 GPM operation in a low-volume system that flows only 75 GPH (1.25 GPM) is the same as using no regulator at all. Remember, Rain Bird's 3/4" low-flow pressure regulators are red-labeled and work from 0.1 to 5.0 GPM (6-300 GPH) while the medium flow 3/4" regulators are yellow-labeled and work from 2 to 22 GPM. The 1" regulators do not carry any labels and are clearly marked 2-22 GPM.

Maximum Inlet Pressure

Whenever the inlet pressure to be regulated exceeds the regulator's rated outlet pressure by more than 50 PSI, install two regulators in series. This will eliminate the loud, high-pitched sound that occurs when the pressure drop across the regulator exceeds 50 PSI.

The regulators on the following page (Table 9-7) are available from Rain Bird.



TABLE 9-7: RAIN BIRD PRESSURE REGULATORS				
Model	Size	Outlet Pressure	Label Color	Flow Range
PSI-L30X-075	3/4"	30 PSI/2,0 BARS	Red	0.1-5.0 GPM
PSI-M30X-075	3/4"	30 PSI/2,0 BARS	Yellow	2.0-22.0 GPM
PSI-M40X-075	3/4"	40 PSI/2,8 BARS	Yellow	2.0-22.0 GPM
PSI-M50X-075	3/4"	50 PSI/3,5 BARS	Yellow	2.0-22.0 GPM
PSI-M40X-100	1"	40 PSI/2,8 BARS	N/A	2.0-22.0 GPM
PSI-M50X-100	1"	50 PSI/3,5 BARS	N/A	2.0-22.0 GPM

Hydraulics Worksheet

Designing a low-volume irrigation system with proper hydraulics will help keep emission devices operating properly. As a rule, you should design the system so that at least 15 PSI of water pressure is available for flushing at the end of each tubing run. This pressure can drop to 8.6 PSI for Landscape Dripline inline tubing provided no supplemental emitters are used. The following worksheet can help you organize your calculations for system hydraulics.

HYDRAULICS WORKSHEET	
Hydrozone:	
Flow (GPM):	
CALCULATE:	PSI
1. Static pressure at water source <i>Enter PSI</i>	
2. Net change in elevation from water source to end of tubing run <i>Multiply feet (+,-) by .433</i>	
3. Friction loss in mainline pipe from water source to hydrozone <i>Refer to friction loss tables in Appendix C</i>	
4. Friction loss due to fittings in mainline pipe from water source to valve <i>Usually estimate 15-20% of main line PSI loss.</i>	
5. Friction loss due to control zone <i>Refer to Table 9-5</i>	
6. Friction loss in lateral PVC pipe from valve to top of riser in hydrozone <i>Refer to friction loss tables in Appendix C</i>	
7. Friction loss due to fittings in lateral PVC pipe from valve to hydrozone <i>Usually estimate 20-25% of lateral line loss.</i>	
TOTAL PRESSURE AT INLET <i>Should be at least 30 PSI</i>	

Figure 9-5: Hydraulics Worksheet

10

INSTALLATION, MAINTENANCE AND TROUBLESHOOTING

Installation

Installation of low-volume irrigation components, while slightly different from conventional-system installation, is a straight forward process. The following steps define a typical low-volume installation.

1. Analyze the site. Compare the site to your irrigation plan and note any obstructions or discrepancies. Modify your plan to reflect actual site conditions.
2. Locate or mark components. Use chalk or flags to mark the locations of valves, trenches, etc.
3. Plant large-specimen plant material.
4. Install and set up backflow devices to meet local codes.
5. Trench and lay main line to the control zone.
6. Pressure test the main line.
7. Set valve boxes and install control zone components.
8. Flush the valves.
9. Run lateral PVC pipe or high density polyethylene pipe to riser units. Each riser unit includes the fittings necessary to connect a 1/2" schedule 80 riser to the poly drip tubing (typically a compression elbow or tee).
10. Backfill trenches and rough grade.
11. Plant shrubs and trees.



12. Layout XT-700 poly drip tubing or Landscape Dripline using fittings as needed. Warm the tubing in the sun before installing to make it more flexible. Don't pull tubing too tight; allow for expansion and contraction due to changing weather conditions.
13. Flush the line to remove debris.
14. Attach emission devices.
15. Staple XT-700 poly drip tubing or Landscape Dripline to grade.
16. Finish grade.
17. Plant ground cover.
18. Operate system for approximately two weeks, checking for correct operation of all emission devices.
19. Flush system to remove any debris.
20. Mulch to cover system components and conserve water.

Maintenance and Troubleshooting

There is a common misconception that low-volume irrigation systems require far more maintenance than conventional irrigation systems. In fact, the conventional systems also require substantial maintenance to keep them operating optimally. However, conventional systems tend to be more “forgiving” of poor maintenance practices. Since the entire area is being irrigated, it is more likely that individual plants will be able to survive a poorly adjusted system.

In low-volume irrigation, each plant receives only as much water as it actually requires. As a result, a clogged emitter or similar problem can cause extreme stress to the plant that relies on that emitter for its water needs.

While the amount of maintenance for a low-volume system will not differ much from conventional systems, the type of maintenance will. In a conventional system, regular site reviews and system checks can determine problem areas fairly easily, but once a problem is found, it may be quite difficult to repair.

In a low-volume system, maintenance is more detail-oriented. Filters must be cleaned on a regular basis, depending on the water source being used. Site reviews require close scrutiny for signs of plant stress caused by a clogged emitter. However, once a problem is found, it can generally be fixed on the spot. Table 10-1 outlines the recommended maintenance for low-volume systems. Table 10-2 includes a list of common system problems and their typical causes and solutions.

TABLE 10-1: RECOMMENDED MAINTENANCE

Interval	Action
Design/Installation phase	Consider accessibility of valves, filters, and emission devices to maintenance personnel. During installation, make sure components are placed for easy access. Completely flush the system prior to operation to remove all debris. Be especially careful to keep pipe shavings and burrs from rigid PVC tubing out of the lines.
After two weeks of operation	<p>Inspect and clean all filters. Establish a cleaning schedule based on the amount of debris found during inspection.</p> <p>Perform walk-through inspection for signs of plant stress. Run system and carefully check each emission device for proper operation. Listen for running water that could indicate breaks in lines.</p> <p>Flush lines and look for signs of debris in water. Debris or suspended matter in the water could indicate breaks in the lines or failed filters. If no breaks or damaged filters are found, consider replacing filters with finer mesh screens.</p> <p>Adjust emission devices to assure that wetting patterns are within plant root zones. If wetting pattern can be seen on top of soil, be sure that it overlaps the base of the plant to provide leaching of salts away from the plant.</p>
Every 1-2 months or as needed based on experience	Examine and clean all filters. Replace filter screens if necessary. Perform a walk-through to look for signs of plant stress. Check all emission devices for location and flow. Adjust, clean, or replace emission devices as required.
Twice per year or more frequently if poor water quality	Flush all lines. Examine water sample for signs of debris and suspended matter. Flush until water runs clear (should take only a few seconds).

TABLE 10-2: TROUBLE SHOOTING

Problem	Potential Cause/Solution
Valve does not operate properly.	<ul style="list-style-type: none"> • Wrong valve selected, flow too low. Replace with correct size Xerigation Control Zone. • Valve diaphragm is contaminated. Clean or replace diaphragm. • Solenoid faulty or wire severed. Check wiring. Repair or replace solenoid.
Emission device has uneven or no flow.	<ul style="list-style-type: none"> • Line severed upstream of emission device. Check for breaks and repair. • Filter clogged or inadequate. Check, clean, or replace filter. • Emission device clogged or faulty. Replace emission device. • Pressure too high or too low. Check pressure regulator to assure flow compatibility. • Too many emission devices on one line or line sized improperly for flow. Check and correct.
Emission device flow is too high or too low.	<ul style="list-style-type: none"> • Check to make sure emission device is not installed backwards. Remember, the pointed end of a Xeri-Bug or PC Module is the inlet.
Poly drip tubing comes out of fittings when line is pressurized.	<ul style="list-style-type: none"> • Fitting improperly installed, or wrong size fitting has been used. Check and replace. • Pressure too high because regulator is not matched to flow.
Emission devices come loose from tubing.	<ul style="list-style-type: none"> • Emission device installed improperly. Emitter punch tool creating holes that are too big resulting in emitters that are loose. • Pressure too high. Check pressure regulator to assure flow compatibility and whether installation is in correct direction. • Faulty or worn hole punch. Replace bad section of tubing and use Xeri-Tool to insert XB emitters with self-piercing barbs so that maximum retention strength is obtained.
Plants appear stressed.	<ul style="list-style-type: none"> • Tubing stake was not used and point of emission has been moved away from plant root zone due to maintenance. • Emission device at plant is clogged. Clean or replace emission device. • Filter is clogged and preventing flow. Clean or replace filter. • Check for and repair breaks in 1/4" or 1/2" line upstream of the emitter. • Run time inadequate for plant and/or time of year. Recalculate water requirement and schedule. • Controller faulty or off. Check controller and reset, repair, or replace.

A

FORMULAS FOR XERIGATION DESIGN

K_C is an adjustment factor to PET that accounts for the needs of a specific plant in specific growing conditions. It is also known as the “crop coefficient” or the “plant factor.”

The formula for K_C is:

$$K_C = \text{Species Factor} \times \text{Density Factor} \times \text{Microclimate Factor}$$

Water Requirement For a Dense Planting Scheme

The water requirement for a densely planted hydrozone is measured in inches per day.

The formula for the water requirement of a densely planted area is:

$$\text{Water Requirement (inches per day)} = K_C \times \text{PET}$$

Where:

K_C = Crop coefficient (plant factor) of the base plant

PET = Published daily evapotranspiration rate (inches per day)

Plant Canopy Area

In order to determine the water requirement of individual plants you must first calculate the area of the plant’s canopy.

The formula for the area of a plant’s canopy is:

$$\text{Area (square feet)} = 0.7854 \times \text{Diameter (feet)} \times \text{Diameter (feet)}$$



Water Requirement For a Sparse Planting Scheme The water requirement for an individual plant is measured in gallons per day.
The formula for the water requirement for an individual plant is:

$$\text{Water Requirement (GPD)} = \frac{.623 \times A \times K_c \times \text{PET}}{e}$$

Where:

A = Area of the plant's canopy (square feet)

K_c = Crop coefficient (plant factor) of the plant

PET = Published daily evapotranspiration rate (inches per day)

e = Application efficiency (percentage in decimal form)

Maximum System Run Time Knowing the maximum system run time helps to avoid wasted water due to run-off or deep percolation. Keep in mind that the actual system run time will generally be less than the maximum run time.

The formula for maximum system run time¹ is:

$$\text{Maximum Run Time (hours)} = \frac{0.000361 \times C \times \text{AW} \times D \times S^2}{q \times e}$$

Where:

C = Allowable water depletion (percentage in decimal form)

AW = Available Water (inches per foot)

D = Desired watering depth (inches)

S = Emitter spacing (inches)

q = Flow rate (GPH)

e = Efficiency (percentage in decimal form)

¹Developed at California Polytechnic University, Pomona by Professor Joseph Y. T. Hung, 1993.



Irrigation Interval Once you calculate the system run time and the maximum run time, you can determine how often to run the system.

$$\text{Maximum Irrigation Interval (days)} = \frac{\text{Maximum Run Time}}{\text{Calculated Run Time}}$$

The general formula for system run time is:

$$\text{Run Time (hours)} = \frac{\text{Water Requirement}}{\text{Flow}}$$

However, since the water requirements are measured differently for sparse plantings and dense plantings, you must apply the formula differently.

System Run Time *Dense Planting Scheme*

The formula for system run time for dense plants is based on a measurement of flow in inches per day. We call this measurement “Emitter Discharge Rate” or EDR. EDR is measured in inches per hour.

The formula for determining EDR is:

$$\text{EDR (inches per hour)} = \frac{231.0 \times q}{s \times l}$$

Where:

q = emitter flow rate (gallons per hour)

s = emitter spacing (inches)

l = lateral spacing (inches)

EDR must be further adjusted by multiplying it by the application efficiency (percentage) to arrive at “Adjusted EDR.”

The formula for system run time for dense plantings is:

$$\text{Run Time (hours)} = \frac{\text{Water Requirement (inches per day)}}{\text{Adjusted EDR (inches per hour)}}$$



The result can be converted from hours to minutes by multiplying it by 60 minutes.

Sparse Planting Scheme

The formula for system run time for a sparse planting scheme is shown below. The water requirement of the base plant must be used and is measured in gallons per day:

$$\text{Run Time (hours)} = \frac{\text{Water Requirement (gallon per day)}}{\text{Total Flow at Base Plant (GPH)}}$$

Number of Emitters The number of emission devices required for an individual plant will depend on the following:

- Area of root zone.
- Plant water requirement.
- Percent of root zone to be wetted.

The formula is:

$$\text{Number of Emitters} = \frac{\text{Plant Area (sq. ft.)} \times \text{Percent to be Wetted}}{\text{Area Wetted by One Emitter (sq.ft.)}}$$

B

PET DATA

Alabama	
Birmingham	.20
Montgomery	.21
Mobile	.20
Alaska	
Anchorage	.16
Fairbanks	.20
Arizona	
Flagstaff	.23
Phoenix	.30
Tuscon	.27
Arkansas	
Fort Smith	.20
Little Rock	.20
Texarkana	.21
California	
Bakersfield	.25
Eureka	.18
Fresno	.25
Los Angeles	.20
Palm Springs	.37
Sacramento	.20
San Francisco	.15

Colorado	
Alamosa	.15
Denver	.18
Pueblo	.20
Connecticut	
Hartford	.20
New Haven	.20
Delaware	
Wilmington	.20
Florida	
Fort Meyers	.24
Jacksonville	.25
Key West	.24
Pensacola	.26
Tampa	.26
Georgia	
Atlanta	.23
Augusta	.24
Macon	.23
Savannah	.24
Hawaii	
Hilo	.17
Honolulu	.20
Kahului	.20
Lihue	.19

Idaho	
Boise	.24
Lewiston	.23
Pocatello	.22
Illinois	
Chicago	.19
Peoria	.20
Springfield	.21
Indiana	
Evansville	.21
Fort Wayne	.20
Indianapolis	.21
South Bend	.20
Iowa	
Des Moines	.21
Sioux City	.20
Waterloo	.19
Kansas	
Dodge City	.26
Topeka	.25
Wichita	.26
Kentucky	
Lexington	.19
Louisville	.20



Louisiana	
Baton Rouge	.20
Alexandria	.20
New Orleans	.20
Maine	
Caribou	.13
Portland	.16
Maryland	
Baltimore	.16
Massachusetts	
Boston	.20
Pittsfield	.19
Michigan	
Detroit	.20
Lansing	.19
Muskegon	.17
Minnesota	
Duluth	.15
Minneapolis-St. Paul	.20
Rochester	.19
Mississippi	
Biloxi	.19
Tupelo	.21
Vicksburg	.21
Missouri	
Kansas City	.21
St. Louis	.20

Montana	
Billings	.24
Glasgow	.23
Helena	.20
Miles City	.24
Missoula	.20
Nebraska	
Norfolk	.20
North Platte	.20
Omaha	.23
Scottsbluff	.25
Valentine	.25
Nevada	
Elko	.20
Las Vegas	.30
Reno	.23
New Hampshire	
Concord	.13
Mt. Washington	.11
New Jersey	
Atlantic City	.19
Newark	.17
Trenton	.19

New Mexico	
Albuquerque	.30
Carlsbad	.31
Clovis	.27
Las Cruces	.33
New York	
Albany	.16
Buffalo	.15
New York	.19
Syracuse	.15
North Carolina	
Charlotte	.19
Raleigh	.19
Wilmington	.20
North Dakota	
Bismark	.20
Fargo	.19
Minot	.20
Ohio	
Cleveland	.21
Columbus	.23
Dayton	.23
Portsmouth	.23
Oklahoma	
Oklahoma City	.30
Tulsa	.28

Oregon	
La Grande	.20
Portland	.18
Roseburg	.20
Pennsylvania	
Erie	.16
Harrisburg	.17
Philadelphia	.20
Pittsburgh	.18
Rhode Island	
Providence	.19
South Carolina	
Charleston	.19
Columbia	.20
Spartanburg	.18
South Dakota	
Huron	.25
Rapid City	.25
Sioux Falls	.24
Tennessee	
Chattanooga	.16
Nashville	.19
Memphis	.17

Texas	
Abilene	.28
Amarillo	.27
El Paso	.29
Fort Worth	.28
Houston	.27
Laredo	.30
San Antonio	.27
Utah	
Salt Lake City	.21
St. George	.32
Moab	.33
Vermont	
Burlington	.17
Virginia	
Norfolk	.19
Richmond	.19
Roanoke	.18

Washington	
Aberdeen	.13
Seattle	.15
Spokane	.19
Yakima	.20
West Virginia	
Charleston	.16
Clarksburg	.15
Wisconsin	
Green Bay	.19
La Crosse	.18
Madison	.20
Milwaukee	.18
Wyoming	
Cheyenne	.19
Jackson	.20
New Castle	.25
Sheridan	.22



C

FRICITION LOSS AND PERFORMANCE DATA

Landscape Dripline

METRIC

Model	Flow GPH	Spacing in.	Coil Length ft.	Model	Flow l/h	Spacing cm	Coil Length m
LD-06-12-100	.61	12	100	LD-06-12-100	2,3	30,5	30,5
LD-06-12-500	.61	12	500	LD-06-12-500	2,3	30,5	152,4
LD-09-12-100	.92	12	100	LD-09-12-100	3,5	30,5	30,5
LD-09-12-500	.92	12	500	LD-09-12-500	3,5	30,5	152,4
LD-06-18-100	.61	18	100	LD-06-18-100	2,3	45,7	30,5
LD-06-18-500	.61	18	500	LD-06-18-500	2,3	45,7	152,4
LD-09-18-100	.92	18	100	LD-09-18-100	3,5	45,7	30,5
LD-09-18-500	.92	18	500	LD-09-18-500	3,5	45,7	152,4
LD-06-24-100	.61	24	100	LD-06-24-100	2,3	61,0	30,5
LD-06-24-500	.61	24	500	LD-06-24-500	2,3	61,0	152,4
LD-09-24-100	.92	24	100	LD-09-24-100	3,5	61,0	30,5
LD-09-24-500	.92	24	500	LD-09-24-500	3,5	61,0	152,4

Control Zone Kit Friction Loss Characteristics

METRIC

Flow GPM	GPH	XACZ-075 psi	XCZ-075 psi	75-DVX psi	XCZ-100 psi	Flow m ³ /h	l/h	l/s	XACZ-075 Bars	XCZ-075 Bars	75-DVX Bars	XCZ-100 Bars
1	60	5.1	3.5	2.5	1.0	0,23	227	0,06	0,35	0,24	0,17	0,07
3	180	5.1	3.5	2.5	1.0	0,68	682	0,19	0,35	0,24	0,17	0,07
5	300	5.4	3.6	2.9	1.2	1,14	1137	0,32	0,37	0,25	0,20	0,08
10*	600	9.9	7.5	3.8	5.1	2,27	2274	0,63	0,68	0,52	0,26	0,35
15*	900	15.9	12.7	4.2	8.8	3,41	3411	0,95	1,10	0,88	0,29	0,61
20*	1200	24.2	20.2	5.1	14.3	4,54	4548	1,26	1,67	1,39	0,35	0,99

XCZ-075 pressure loss data above 5 GPM is with PSI-M30X pressure regulator.
Maximum flow rate with "M" style regulators is 22 GPM.

* For flows below 3 GPM (0,7 m³/h; 0,11 l/s), always use RBY Series 200 mesh (75-micron) filter installed upstream of valve.

**For flows greater than 5 GPM/300 GPH (1,14 m³/h; 0,32 l/s; 1.135,50 l/h), substitute PSI-L30X with a PSI-M30X pressure regulator.

Landscape Dripline Maximum Lateral Lengths

Inlet Pressure psi	Maximum Lateral Length (feet)		18" Spacing		24" Spacing	
	12" Spacing	Nominal Flow (GPH): .6	Nominal Flow (GPH): .6	Nominal Flow (GPH): .9	Nominal Flow (GPH): .6	Nominal Flow (GPH): .9
15	159	130	222	174	283	214
25	252	171	359	231	457	287
35	304	211	435	289	558	358
45	342	236	489	322	627	399
60	392	268	558	365	716	453

METRIC

Inlet Pressure Bars	Maximum Lateral Length (Meters)					
	30,5 cm	45,7 cm	61,0 cm			
	Nominal Flow (l/h): 2,3	Nominal Flow (l/h): 3,5	Nominal Flow (l/h): 3,5			
1,0	48,5	39,6	67,7	53,0	86,3	65,2
1,7	76,8	52,1	109,4	70,4	139,3	87,5
2,4	92,7	64,3	132,6	88,1	170,1	109,1
3,1	104,2	71,9	149,0	98,1	191,1	121,6
4,1	119,5	81,7	170,1	111,0	218,2	138,1

Landscape Dripline Emitter Discharge Rate vs. Pressure

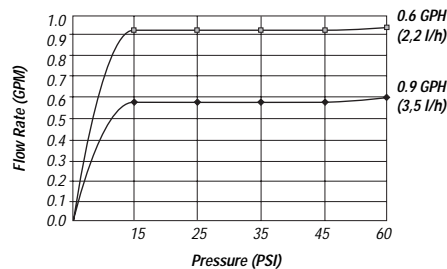

Pressure-Compensating Modules

METRIC

100-Mesh Filtration Required

Model	Outlet/Color	Nominal Flow GPM
PC-05	Light Brown	5
PC-07	Violet	7
PC-10	Green	10
PC-12	Dark Brown	12
PC-18	White	18
PC-24	Orange	24

150-Micron Filtration Required

Model	Outlet/Color	Nominal Flow m ³ /h	l/h
PC-05	Light Brown	0,02	18,95
PC-07	Violet	0,03	26,53
PC-10	Green	0,04	37,90
PC-12	Dark Brown	0,05	45,48
PC-18	White	0,07	68,22
PC-24	Orange	0,09	90,96

Pressure-Compensating Modules Performance

METRIC

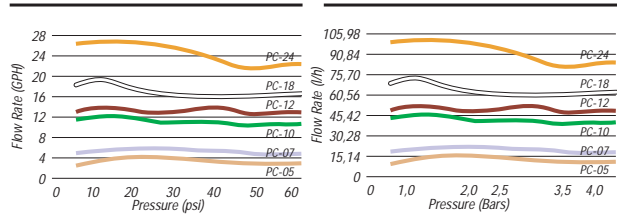

Xeri-Bubbler Performance

Fully open (approximately 22 clicks)

Pressure psi	SXB-360		SXB-180		UXB-360	
	Flow GPH	Radius of Throw ft.	Flow GPH	Radius of Throw ft.	Flow GPH	Radius of Throw ft.
15	8.7	0.6	8.7	1.2	28.5	0.7
20	10.3	1.0	10.3	1.5	31.0	1.1
30	13.0	1.5	13.0	2.0	35.0	1.9

METRIC

Fully open (approximately 22 clicks)

Pressure Bars	SXB-360		SXB-180		UXB-360				
	Flow m ³ /h	Radius of Throw m	Flow m ³ /h	Radius of Throw m	Flow m ³ /h	Radius of Throw m			
1,0	0,03	32,97	0,18	0,03	32,97	0,37	0,11	108,02	0,21
1,5	0,04	40,82	0,34	0,04	40,82	0,49	0,12	120,13	0,38
2,0	0,05	48,25	0,45	0,05	48,25	0,60	0,13	131,11	0,55
2,1	0,05	49,27	0,46	0,05	48,27	0,61	0,13	132,65	0,58



1/4" Distribution Tubing Friction Loss Characteristics

O.D. .220" I.D. .160"			O.D. 6 mm I.D. 4 mm		
Flow GPH	Velocity fps	psi Loss	Flow m ³ /h	Velocity l/h	Bars
1	0.27	0.16	0.00	3.79	0.08
2	0.53	0.59	0.01	7.58	0.16
3	0.80	1.24	0.01	11.37	0.24
4	1.06	2.12	0.02	15.16	0.32
5	1.33	3.20	0.02	18.95	0.41
6	1.59	4.49	0.02	22.74	0.48
7	1.86	5.97	0.03	26.53	0.57
8	2.13	7.64	0.03	30.32	0.65
9	2.39	9.50	0.03	34.11	0.73
10	2.66	11.54	0.04	37.90	0.81
11	2.92	13.79	0.04	41.69	0.89
12	3.19	16.17	0.05	45.48	0.97
13	3.45	18.75	0.05	49.27	1.05
14	3.72	21.50	0.05	53.06	1.13
15	3.98	24.43	0.06	56.85	1.21
16	4.25	27.53	0.06	60.64	1.30
17	4.52	30.80	0.06	64.43	1.38
18	4.78	34.23	0.07	68.22	1.46
19	5.05	37.83	0.07	72.01	1.54
20	5.31	41.60	0.08	75.80	1.62
25	6.64	62.86	0.09	94.75	2.03
30	7.97	88.08	0.11	113.70	2.43

psi Loss Per 100 Feet of tubing: C=150

Bars Loss per 100 Meters of tubing

Note: Use of tubing at flows shown in dark shaded area is not recommended, as velocities exceed 5 ft./sec. (1.5 m/s).

Xeri-Bug Emitter Specifications and Models

Model	Inlet/Color	Nominal Flow GPH	Filtration Required mesh	Model	Inlet/Color	Nominal Flow l/h	Filtration Required microns
XB-05	Barb/Blue	0.5	200	XB-05	Barb/Blue	1.90	75
XB-10	Barb/Black	1.0	150	XB-10	Barb/Black	3.79	100
XB-20	Barb/Red	2.0	150	XB-20	Barb/Red	7.58	100
XBT-10	Thread/Black	1.0	150	XBT-10	Thread/Black	3.79	100
XBT-20	Thread/Black	2.0	150	XBT-20	Thread/Black	7.58	100

Xeri-Bug Emitter Performance

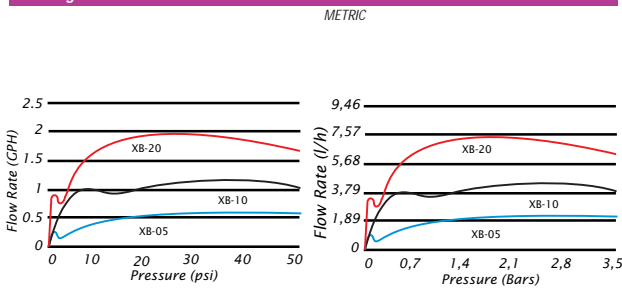

Multi-Outlet Xeri-Bug Emitter Performance

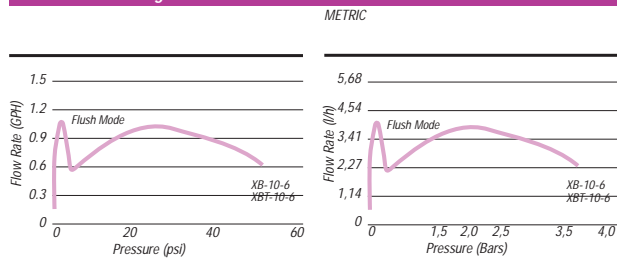

In-Line WYE Filter

Pressure Loss (psi)				Pressure Loss (Bars)				
Flow Rate GPM	100 mesh	150 mesh	200 mesh	Flow m ³ /h	l/s	150 micron	100 micron	75 micron
RBV-075								
5	0	0	0.5	1.14	0.32	0.00	0.00	0.03
10	0.5	0.5	1.5	2.27	0.63	0.03	0.03	0.10
15	2.4	2.6	2.9	3.41	0.95	0.17	0.18	0.20
20	5.2	5.4	5.4	4.54	1.26	0.36	0.37	0.37
30	12.0	12.5	13.0	6.81	1.89	0.83	0.86	0.90
RBV-100								
5	0	0	0	1.14	0.32	0.00	0.00	0.00
10	0.5	0.5	0.5	2.27	0.63	0.03	0.03	0.03
15	2.1	2.2	2.5	3.41	0.95	0.14	0.15	0.17
20	4.7	4.9	4.9	4.54	1.26	0.32	0.34	0.34
30	8.6	8.8	8.8	6.81	1.89	0.59	0.61	0.61

Replacement Filter Elements

Model	Size Filtration	Color	Model	Size Filtration	Color
RBV-100MX	100-mesh filter	Red	RBV-100MX	150-micron filter	Red
RBV-150MX	150-mesh filter	Blue	RBV-150MX	100-micron filter	Blue
RBV-200MX	200-mesh filter	White	RBV-200MX	75-micron filter	White

Xeri-Tube™ 700 Friction Loss Characteristics

O.D. .700" I.D. .580"			O.D. 18mm I.D. 15mm			
Flow GPM	Velocity fps	Loss psi	Flow m ³ /h	Flow l/h	Velocity m/s	Loss Bars
0.50	0.61	0.19	0.11	0.03	0.19	0.01
1.00	1.21	0.69	0.23	0.06	0.37	0.05
1.50	1.82	1.45	0.34	0.09	0.56	0.10
2.00	2.43	2.47	0.45	0.13	0.74	0.17
2.50	3.03	3.74	0.57	0.16	0.92	0.26
3.00	3.64	5.24	0.68	0.19	1.11	0.36
3.50	4.24	6.97	0.79	0.22	1.29	0.48
4.00	4.85	8.93	0.91	0.25	1.48	0.62
4.50	5.46	11.10	1.02	0.28	1.67	0.77
5.00	6.06	13.50	1.14	0.32	1.85	0.93
5.50	6.67	16.10	1.25	0.35	2.03	1.11
6.00	7.28	18.92	1.36	0.38	2.22	1.31

psi Loss per 100 Feet of Pipe (psi/100ft.) C=140

Bars Loss per 100 Meters of Pipe (Bars/100m)

Note: Use of tubing at flows shown in dark shaded area is not recommended, as velocities exceed 5 ft./sec. (1.5 m/s).

D

XERIGATION PLANNING FORMS

Photocopy the planning forms on the following pages and use them to help you plan your Xerigation projects.



Hydrozones (Attach sketch of property) # DESCRIPTION	IRRIGATION METHOD																																		
DENSITY																																			



LOW-VOLUME DESIGN WORKSHEET: SPARSE HYDROZONE

DATE
JOB NUMBER

1 Site Information

Name _____
 Address _____
 City _____ State _____ Zip _____
 Contact _____
 Day Phone _____ Eve. Phone _____
 Daily PET (inches per day) _____
 Application Efficiency _____

Soil Type: Coarse
 Medium
 Fine

5 SYSTEM RUN TIME

1 HYDROZONE

DESCRIPTION

Minimum Area To Be Wetted
 0.7854 X Diameter X Diameter X 50% = Square Feet

Water Requirement
 .623 X Area X K_c X PET = Gallons per Day (GPD)
 Application Efficiency

2 PLANT SPECIES	SPECIES FACTOR	DENSITY FACTOR	MICROCLIMATE FACTOR	K _c	3 PLANT DIAMETER (FT.)	CANOPY AREA (SQ. FT.)	WATER REQUIREMENT (GPD)	4 TYPE	6 EMISSION DEVICES	FLOW	QUANTITY	SPACING



LOW-VOLUME DESIGN WORKSHEET: DENSE HYDROZONE

DATE
JOB NUMBER

1 Site Information

Name John & Wendy Doyle
 Address 7836 Connor Lane
 City Brighton State CA Zip 92867
 Contact John
 Day Phone 714-555-8136 Eve. Phone 714-555-1089
 Daily PET (inches per day) 0.20
 Application Efficiency 90%
 Soil Type: Coarse Medium Fine

Planting Scheme

Ground Cover Only
 Ground Cover/Trees
 Ground Cover /Shrubs
 Ground Cover/Shrubs/Trees
 Shrubs/Trees
 Shrubs Only
Base Plant
 Ground Cover
 Shrubs

4 Watering Depth

3" 18"
 6" 24"
 9" 36"
 12"
Emitter Spacing
 12"
 18"
 24"
 36"

1 HYDROZONE

7
 DESCRIPTION
Mixed G. C. & shrubs
 SYSTEM RUN TIME

Base Plant

BASE PLANT SPECIES	SPECIES FACTOR	DENSITY FACTOR	MICROCLIMATE FACTOR	K _c	WATER REQUIREMENT	EMITTER FLOW RATE	ADJUSTED EDR
Ice Plant	low	high	high				

Water Requirement
 $K_c \times PET =$ Inches per Day

Plant Canopy Area
 $0.7854 \times \text{Diameter} \times \text{Diameter} = \text{Square Feet}$

Non-Base Plants

Water Requirement
 $\frac{.623 \times \text{Area} \times K_c \times PET}{\text{Application Efficiency}} = \text{Gallons per Day (GPD)}$

ADDITIONAL PLANT SPECIES	SPECIES FACTOR	DENSITY FACTOR	MICROCLIMATE FACTOR	K _c	PLANT DIAMETER (FT.)	CANOPY AREA (SQ. FT.)	WATER REQUIREMENT (GPD)	TYPE	EMISSION DEVICES	QUANTITY	SPACING
Azaleas (2)	avg. 0.5	low	high	0.3	4.0	12.6	0.5	P.C. Mod.	7.0	2 per	
Privet (12)	avg. 0.5	med	high	0.7	3.0	7.1	0.7	P.C. Mod.	10.0	2 per	
Hawthorne (6)	avg. 0.5	med	high	0.7	3.0	7.1	0.7	P.C. Mod.	10.0	2 per	
Ferns (2)	high	low	high		5.0			Xeri-Bubbler		2 per	



FLOW RATE WORKSHEET

Use the worksheet below to determine the flow rate for your system:

To Get This:	Do This:	Calculations	Totals
1. Length of tubing in feet:	Determine the total length in feet from grid		
2. Length of tubing in inches:	Multiply feet by 12 to get inches		
3. No. of emitters in the zone:	Divide length by emitter spacing (12", 18", 24")		
4. Total no. of emitters:	Round up to next whole number		
5. Flow rate in GPH:	Multiply no. of emitters by flow rate (0.6 or 0.9 GPH)		
6. Flow rate in GPM:	Divide GPH by 60 to get gallons per minute		

LATERAL LINE SPACING WORKSHEET

Use the worksheet below to determine the space between lateral lines for your system:

To Get This:	Do This:	Calculations	Totals
1. Width of the planted area	Measure the width in feet		
2. Width of planted area in inches:	Multiply feet by 12 to get inches		
3. Actual width of the grid:	Subtract edge offset (multiply 2 x 2 = 4)*		
4. No. of spaces between laterals:	Divide grid width by emitter spacing (12", 18" or 24")		
5. Actual no. of spaces:	Round up to the next whole number		
6. Actual space between lateral lines:	Divide grid width by number of spaces in grid		
7. No. of lateral line rows in the grid:	Add one to no. of spaces		

* The edge offset is 2" from hardscape and 4" from non-hardscape.

E

1/2" polyethylene tubing	a low-volume distribution component typically used to bring water from a Schedule 80 riser into a hydrozone.
1/4" distribution tubing	a low-volume distribution component typically used to bring water directly to plant root zones; also known as "spaghetti" tubing.
allowable depletion	(also known as Management Allowable Depletion) the percent of soil moisture that an irrigator will allow to be depleted before irrigating again; selection of a low allowable depletion requires more frequent irrigation of smaller amounts. A higher allowable depletion will require fewer irrigations of larger amounts. Generally, allowable depletion should not exceed 30-50 percent for a low-volume irrigation system.
base plant	the plant that requires the least amount of water in a given planting scheme, typically is the predominant plant in a dense planting scheme.
capillary action	the primary force in spreading water horizontally through soil.
compression fitting	a fitting used to connect 1/2" poly drip tubing in a low-volume system; compression fittings are attached to the outside of the tube so that the connection becomes tighter as the pressure increases.
control zone	in a low-volume system, a collection of components that controls the flow and pressure of water to the hydrozone; the control zone includes a ball valve, an in-line WYE filter, a remote control valve and a pressure regulator.
controller	a device that automatically opens and closes the valves in an irrigation system according to a pre-set program.
crop coefficient	(also known as the Plant Factor, or K_c) an adjustment factor used to equate actual plant- water use to referenced PET; a given plant type may use less water than the referenced ET rate for an area. Multiplying the plant's crop coefficient by the referenced ET rate adjusts ET to the actual plant water use. Crop coefficient values are not widely available for landscape plants, but they are grouped into one of three categories: low, medium or high water usage. See Chapter 4 for information on calculating crop coefficients.
distribution component	a low-volume irrigation component that brings water to the individual hydrozones and plants; distribution components can include 1/2" polyethylene tubing, 1/4" spaghetti tubing, compression fittings and flex risers.



distribution tubing	<i>See 1/4" distribution tubing.</i>
drip emitter	a low-volume emission device that delivers water at low flow rates, one drip at a time; drip emitters are used to apply water directly to an individual plant root zone.
emission device	a low-volume irrigation component that delivers water directly to the plants; emission devices can include bubblers, drip emitters, microsprays and inline emitter tubing.
filter	a device used in a control zone or multi-outlet emission device to screen dirt and debris from the water; filters are important in low-volume systems because the small emission devices can easily become clogged.
flow	the amount of water, usually measured in gallons per minute or gallons per hour, that can pass through an irrigation system.
GPH	an abbreviation for gallons per hour, which is a measure of the flow of water through an irrigation system; GPH is typically used to measure flow in low-volume irrigation systems.
GPM	an abbreviation for gallons per minute, which is a measure of the flow of water through an irrigation system; GPM is typically used to measure flow in conventional irrigation systems.
hydrozone	a grouping of plants served by one control zone and irrigated by a low-volume system; a hydrozone typically has a common microclimate and may consist of plants with like water requirements or with mixed water requirements.
inline emitter tubing	a polyethylene tube with emitters pre-installed at a specific distance from each other at the factory.
infiltration rate	the rate at which water applied to the soil enters the soil without causing runoff.
low-volume irrigation	a type of watering system in which a precise amount of water is applied directly to the root zones of plants, typically in gallons per hour.
matched hydrozone	a hydrozone in which all of the plants have the same water needs; plants in a matched hydrozone may each be watered by the same type and number of emitters and typically will be watered together on the same valve.
maximum system run time	the longest period of time a low-volume irrigation system can run without water loss to deep percolation (or water penetration below the plant root zone).
micro-bubbler	a low-volume emission device that delivers water at higher flow rates than drip emitters but at lower flow rates than micro-sprays; micro-bubblers are used to apply water directly to an individual plant root zone.

microclimate	a small sub-climate within a project site created by adjacent hardscape, a shade tree or exposure.
micro-spray	a low-volume emission device that operates similarly to a conventional sprayhead, but with much lower flow rates; microsprays are used to water an entire hydrozone rather than individual plant root zones.
mixed hydrozone	a hydrozone in which the plants have different water needs. When plants having different watering needs are grouped together, emission devices will be different for each plant. In many cases, the emitters will be matched for the individual plant needs so that the plant group may be watered on the same valve.
multi-outlet emission device	a low-volume emission device that contains several drip emitters connected to 1/4" distribution tubing; the tubing is then run to several different plants.
planting scheme	the arrangement of plants within a hydrozone; the planting scheme can refer to a dense or sparse configuration, or to matching or mixing by watering needs.
polyethylene tubing	<i>See 1/2" polyethylene tubing.</i>
potential evapotranspiration (PET)	the amount of water that is used by the combination of evaporation from the soil and transpiration from plants growing in the soil; PET is generally expressed in inches per day.
retrofit	the process of changing an existing conventional irrigation system into a low-volume system.
soil types	types of soil determined by their composition; soil is made up of sand, silt and clay particles, the percentage of each determines the soil type. Soil type will affect the irrigation design and watering schedule.
—clay	a medium-fine textured soil that usually forms very hard lumps or clods when dry and is quite plastic and sticky when wet; when the moist soil is pinched between the thumb and finger, it will form a long, flexible ribbon. Some clays are very high in colloids, are friable, and may lack plasticity at all conditions of moisture.
—clay loam	a moderately fine textured soil that usually breaks into clods or lumps that are hard when dry. When the moist soil is pinched between the thumb and finger, it will form a thin ribbon that will break readily, barely sustaining its own weight. The moist soil is plastic and will form a cast that will bear much handling. When kneaded in the hand, does not crumble readily, but tends to work into a heavy compact mass.

soil types, continued

- loam** soil having a mixture of the different grades of sand, silt and clay in such proportion that none of the characteristics predominate; it is mellow with a somewhat gritty feel, and when moist is slightly plastic. Squeezed when dry, it will form a cast that will bear careful handling; the cast formed by squeezing the moist soil can be handled quite freely, without breaking.
- sand** a loose and single-grained soil; the individual grains can easily be seen or felt. Squeezed in the hand when dry, it will fall apart when pressure is released. Squeezed when moist it will form a cast but will crumble when touched.
- sandy loam** a soil containing much sand, but which has enough silt and clay to make it somewhat cohesive; the individual sand grains can readily be seen and felt. Squeezed when dry, it will form a cast that will readily fall apart, but if squeezed when moist, a cast can be formed that will bear careful handling without breaking.
- silt loam** a soil having a moderate amount of the fine grades of sand and only a small amount of clay, over half of the particles being of the size called "silt." When dry, it may appear cloddy, but the lumps can be readily broken. When pulverized, it feels smooth, soft, and floury. When wet, the soil readily runs together. Either dry or moist, it will form casts that can be freely handled without breaking; however, when moistened and squeezed between thumb and finger, it will not "ribbon" but will be broken in appearance.

spaghetti tubing *See 1/4" distribution tubing.*

system efficiency a factor that denotes how efficient the irrigation system is at applying water. When water is discharged from the system, only a certain percentage will reach the plant root zone and be available for consumption. The percentage of water that reaches the plant and is available equals system efficiency. It is impossible to reach a 100% efficiency.

valve a device that opens and closes to allow pressurized water to flow through pipes.

valve box an underground enclosure that protects valves from moisture and other damage.

valve zone a group of sprinklers that are controlled by a single valve (see hydrozone).

water source pressurized water in a city main line or water pumped from a well, lake or pond.

watering window the amount of time available to water in any one period.









wetting pattern the area of the ground that is wet just after irrigation; an ideal wetting pattern covers the root zone of the plant without leaving a puddle.

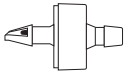

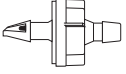

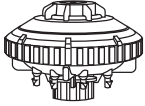
Xeriscape a planting scheme that groups plants with the same irrigation requirements together.

F

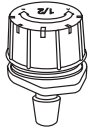
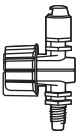

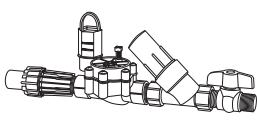
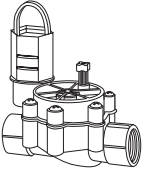
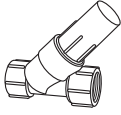
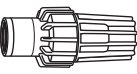
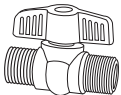
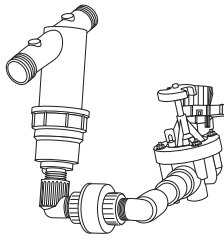

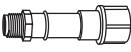





XERIGATION PRODUCT LINE

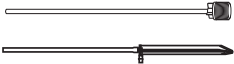
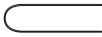
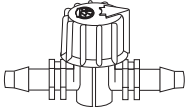

See the Rain Bird Landscape Irrigation Products Catalog for more information.

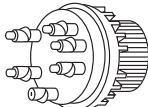
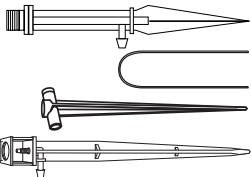
XERIGATION EMISSION DEVICES	
	Xeri-Bug™ Emitter —Available in 0.5, 1.0, and 2.0 GPH flow rates, pressure compensating. (XB-05, XB-10, XB-20).
	Shrub Xeri-Bug™ Emitter —Available in 1.0 and 2.0 GPH flow rates, pressure compensating. Adapts to a standard 1/2" riser (XBT-10, XBT-20).
	Pressure-Compensating Modules —Available flow rates: 5 GPH to 24 GPH (PC-05, PC-07, PC-10, PC-12, PC-18, PC-24).
	Landscape Dripline In-line Emitter Tubing —Factory-installed pressure-compensating emitters at 12", 18" and 24" spacing. Available in 0.6 and 0.9 GPH and 100-, 250- and 500-foot coils.
	Xeri-Bird™ 8 Multi-Outlet Emission Device —Accepts any Xeri-Bug Emitter or Pressure Compensating Module to customize layout options and flows (XBD-80, XBD-81). XBD-KIT for factory-installed XB-10 emitters.
	Multi-Outlet Xeri-Bug™ —Six barbed outlets flow at 1.0 GPH each, pressure compensating. Inlet barb can be installed directly onto Xerigation tubing with the use of a Rain Bird hole punch (XB-10-6).
	Multi-Outlet Shrub Xeri-Bug™ —Six barbed outlets flow at 1.0 and 2.0 GPH each, pressure compensating. 1/2" threaded inlet can be installed on a standard 1/2" riser (XBT-10-6 and XBT-20-6).
	Multi Port Nozzle — 5 possible watering patterns in 1 nozzle. 10.5 GPH from each open port. Available in (1) pre-opened port (MP5S-SQ) or (2) pre-opened ports (MP5S-SST).
	XP Series Xeri-Pops™ —Features a 1/4" barb inlet. Accepts 5, 8 and 10 Series MPR nozzles with flow rates of 30 GPH (0.5 GPM) or less. Available in 2", 4" or 6" pop-up models, they pop up to water and then pop down flush when not in operation so they are practically invisible and less vulnerable to damage. Multi-Port spray nozzle (available Spring 2000) provides five patterns in one low-flow micro-spray nozzle. The Multi-Port nozzle is compatible with all 1800 Series, UNI-Spray Series and Xeri-Pop micro-spray pop-ups.
	Xeri-Bubbler™ Micro-Bubbler Emission Device —Available in 180°, 360° Stream and Umbrella patterns. Models available in 10-32 self-tapping thread (SXB-180, SXB-360, UXB-360), 1/2" FPT (SXB-180-050, SXB-360-050, UXB-360-050), 1/4" barb (SXB-180-025, SXB-360-025, UXB-360-0250 and 5" spike (SXB-180-SPYK, SXB-360-SPYK, UXB-360-SPYK). Adjustable flow 0 to 35 GPH.
	Xeri-Spray™ Micro-Spray Emission Device —Patterns: 90°, 180° and 360°. Four types: 10-32 self-tapping threads (XS-90, XS-180, XS-360), 1/4" barb (XS-360TS-025), 1/2" FPT (XS-90, XS-180, XS-360), 1/4" barb (XS-360TS-025), 1/2" FPT (XS-360TS-050) and 5" stake (XS-360TS-SPYK, XS-360TS-SPYK). Adjustable radius and flow from 0 to 31 GPH.

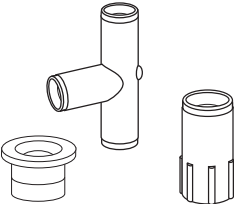
XERIGATION CONTROL ZONE COMPONENTS	
	Xerigation Control Zone Kit —Prepackaged kit includes Ball Valve, Inline Filter, Remote Control Valve, Pressure Regulator, and 3/4" Schedule 80 Nipples (XCZ-075, XCZ-100). With anti-syphon valve use model (075-ASVF), With commercial PEB valve, use XCZ-100COM.
	3/4" DVX Remote Control Valve —(75-DVX). Handles flow from 12 to 900 GPH.
	In-line WYE Filters —Available in 3/4" (RBY-075-200X) or 1" (RBY-100-200X). Three color coded replacement mesh screen sizes are also available: 100-Mesh (RBY-100MX), 150-Mesh (RBY-150MX), 200-Mesh (RBY-200MX).
	In-line Pressure Regulators —Suitable for above- or below-ground installation. (Low flow 0.1-5 GPM: PSI-L30X-075, Medium flow 2-22 GPM: PSI-M30X-075, PSI-M40X-075, PSI-M50X-075, PSI-M40X-100, PSI-M50X-100).
	Ball Valve —Ideal for isolation valve applications. (XBV—075).
	Automatic Filter Kit —Combines Y-filter and fittings with PESB scrubber valve. When connected to filter's flush port, PESB valve can be controlled by timer to regularly flush filter. Specify desired mesh: 30, 50, 100, 150 or 200-mesh. Models: 1" (AF100-LSS), 1-1/2" (AF150-LSS), 2" (AF200-LSS).
XERIGATION RETROFIT COMPONENTS	
	1800 Xerigation Retrofit Kit —Change any 1804, 1806, or 1812 spray system into Xerigation. Includes 200-mesh filtration and 30 PSI regulator. (RETRO-1800).
	Retrofit Pressure Regulator —Fits standard 1/2" riser, regulates pressure to 30 PSI (PRS-050).
	Xeri-Caps™ for Sprayheads —Cap fits over any Rain Bird 1800 (XC-1800) or Toro* 570 (XC-T-570) sprayhead for retrofitting.

* Toro is a registered trademark of Toro Corporation.

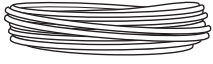
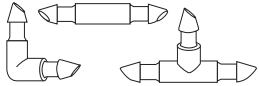
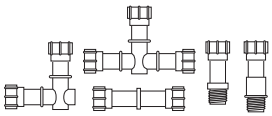
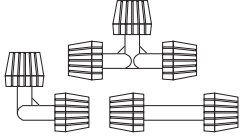
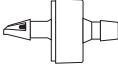
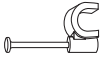
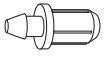
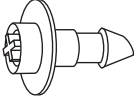
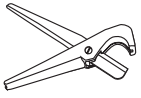
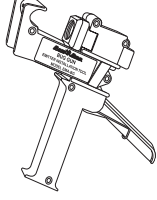
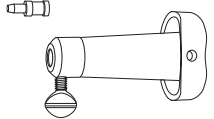
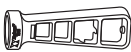
XERIGATION DISTRIBUTION COMPONENTS	
	1800 Xeri-Bubbler Adapter —Allows Xeri-Bubblers to be installed on a Rain Bird 1800 Series Sprinkler. (XBA-1800).
	12" Polyflex Riser —Used in conjunction with Polyflex Riser Adapter (FRA-050) or Flex Riser Stake (RS-025T). Accepts all Xeri-Bubbler and Xeri-Spray emission devices. (PFR-12).
	Threaded Adapter —1/2" FPT inlet screws onto any 1/2" NPT riser. Accepts all Xeri-Bubbler and Xeri-Spray Emission Devices. (10-32A).
	Flex Riser Stake-Threaded —Threaded outlet for polyflex riser (PFR-12), barbed side for 1/4" distribution tubing (RS-025T).
	Polyflex Riser/Adapter and Stake Assemblies —Preassembled riser and adapter. PFR/FRA for PVC, PFR/RS for poly.
	Galvanized Tie-Down Stake —Bend and use as stake for Xeri-Tube™ 700 and Landscape Dripline. (TDS-050).
	Xeri Micro Valves —Adjust or turn off flow. Use XMV-025 with distribution tubing (DT-025) and XMV-1032 with flex risers (PFR-12).
	1/4" Tubing Stake —Holds distribution tubing (DT-025) in place (TS-025).
	6 Outlet Manifold —Gray color indicates unrestricted flow, 1/2" FPT inlet fits any 1/2" NPT riser. Enables user to vary outlet flow by placing an emission device at the end of 1/4" distribution tubing. (EMT-6X).
	Tubing Riser Stake and Accessories —Xeri-Stake™ (700-XS-050) accepts all 1/2" FPT Xerigation products, Galvanized Tie-Down Stake (TDS-050) holds tubing firmly in place, 1/4" Tubing Stake (TS-025) holds 1/4" distribution tubing firmly at plant root zone and Flex-Riser Stake-Threaded (RS-025T) is used for polyflex riser and Xeri-Bubbler/Xeri-Spray applications.
	Xeri-Tube™ 700 —Heavy wall, for above- and below-ground installations. Available in 100-foot coil (XT-700-100) or 500-foot coil (XT-700-500).
	Compression Fittings —700 Series fit Xeri-Tube™ 700 and any tubing with .700" O.D. Models: 1/2" Compression Adapter (700-CF-1), 1/2" Comp x Comp x Comp Tee (700-CF-2), 1/2" Comp x Comp Ell (700-CF-3), 1/2" Comp x Comp x Comp Coupling (700-CF-4). 600-Series fits Landscape Dripline and other .620"-.630" O.D. inline emitter tubing. Models: 1/2" Comp Adapter (600-CF-1), Comp x Comp x Comp Tee (600-CF-2), Comp x Comp Ell (600-CF-3), Comp x Comp Coupling (600-CF-4). For others, see catalog.
	Tubing End Closures —Compression Flush Caps (700-CF-21) and Figure-8 End Closures (700-CF-22) are used at the end of drip tubing laterals.

DISTRIBUTION COMPONENTS CONTINUED	
	1/4" Distribution Tubing —Available in 50 and 100 foot coils (DT-025-050 and DT-025-100) or 1500 foot reel (DT-025-1500).
	1/4" Barb Transfer Fittings —Used to connect 1/4" distribution tubing (DT-025) together. 1/4" Barb Connector (BF-1), 1/4" Barb x Barb Ell (BF-2), and 1/4" Barb x Barb x Barb Tee (BF-3).
	LOC Fittings —Elbow, coupling and tee. Works with 600 and 700 series tubing. O ring design for leak-free connections.
	Universal Fittings —Elbow, coupling and tee. Works with all tubing from 3/4" — 1/2".
	1/4" Self-Piercing Barb Connector —Used as a transfer fitting from Xerigation tubing to 1/4" distribution tubing (SPB-025).
	1/4" Mounting Clip —Used to attach 1/4" distribution tubing (DT-025) to wood and masonry (MC-025).
	Tubing Goof Plug —Plugs any unwanted holes made by removing emission devices from Xerigation tubing (EMA-GPX).
	Diffuser Bug Cap —Fits into 1/4" distribution tubing and diffuses water to minimize soil erosion at emission point. Also prevents bugs and debris from clogging tubing (DBC-025).
XERIGATION TOOLS	
	Tubing Cutter —Designed for cutting all Xerigation tubing (PPC-200X).
	Bug Gun Emitter Installation Tool —Used with Rain Bird self-piercing emitters. Installs emitters on pressurized or non-pressurized tubing. (EMA-BGX).
	Hole Punch Tool and Replacement Tips —Used for installing emission devices into Xerigation tubing. (EMA-RBPX tool and EMA-CTX replacement tips).
	Xeriman™ Tool —Multi-function tool for use with Rain Bird drip/low-volume components (XM-TOOL).
	Multi Port Nozzle Punch Tool —Use to open additional watering ports on the Multi Port Nozzle.



INSTALLATION DETAILS

Installation details for Xerigation products can be downloaded from Rain Bird's website at:

www.rainbird.com.

1. From the Rain Bird home page, click on Landscape Drip.
2. From the Xerigation home page, click on Technical Information.
3. From the Technical Information page, click on Download Files.
4. From the Download Technical Information page, follow the instructions and click on the appropriate file type (xeri.exe, jxeri.exe, wxeri.exe, dxeri.exe) under the Xerigation category.

OR

Go directly to the Download Technical Information page and follow the instructions at:

www.rainbird.com/rbturf/technical/download.htm

From the Download Technical Information page, follow the instructions and click on the appropriate file type (xeri.exe, jxeri.exe, wxeri.exe, dxeri.exe) under the Xerigation category.



BIBLIOGRAPHY

Drip Irrigation Design for Landscapes, by Joseph Y. T. Hung, Paper Number 88-2066 presented at the American Society of Agricultural Engineers, Rapid City, SD, 1988.

Determining Drip Emitter Spacing and Watering Time for Maximum Water Use Efficiency, by Joseph Y. T. Hung, Paper presented at the Irrigation Association, San Diego, CA, 1993.

Estimating Water Requirements of Landscape Plantings: The Landscape Coefficient Method, Cooperative Extension University of California, Division of Agriculture and Natural Resources, Leaflet 21493.

Water Use Classification of Landscape Species, (WUCOLS Project), Cooperative Extension University of California, February 1992.

Landscape Drip Irrigation Design Manual, by Keith Shepersky, Rain Bird Sales, Inc., 1984.

Irrigation Principles and Practices, Fourth Edition, by Vaughn E. Hansen, Orson W. Israelsen, Glen E. Stringham, 1979.

Rain Bird Trickle Irrigation Design, First Edition, by Jack Keller, Ph. D. and David Karmeli, Ph. D., Rain Bird Sprinkler Manufacturing Corp., 1975.

For more information about the Landscape and Irrigation Design program at California State Polytechnic University, Pomona, California, call 909-869-2220.

INDEX

—A—

Adjusted EDR, 44
Allowable depletion, 46
Application efficiency, 14, 17, 25, 44
Application, emission device, 30
Area

canopy, 39
mature canopy, 40
minimum to be wetted, 40
plant canopy, 25
root zone, 39
wetted per emitter, 40

Available water, 12

—B—

Base plant, 29
dense hydrozone, 21
irrigating, 29
sparse hydrozone, 29, 38

—C—

Canopy, mature, 25
Capillary action, 11
City water, 10
Clay, 11
Climate, 11
Coefficient, crop, 21
Container plants, irrigating, 62
Control zone, 14, 69
Controller, 45
Conventional irrigation, 5, 14
Cool dry climate, 14
Cool humid climate, 14
Crop coefficient, 21, 24
Cycle, wet/dry, 3

—D—

Dense Hydrozone Design Worksheet, 20
Dense hydrozone, water requirements, 21
Dense plants, 7
emission devices, 32
system run time, 44
water requirement, 24
Density factor, 22
Depletion, allowable, 46
Depth
emission device, 30, 39, 55
minimum watering, 36
root, 36
Design process, 6
Design Worksheet
Dense Hydrozone, 20
Sparse Hydrozone, 20
Desired watering depth
minimum, 36

Diameter, plant, 24
Dirty water, 10
Discharge rate, emitter, 44
DV Valve, 69
Dynamic pressure, 63

—E—

EDR, 44
EDR, adjusted, 45
Efficiency, application, 14, 25, 44
Effluent, 10
Elevation, 63
Emission device
depth, 36
flow rate, 37
non-base plants, 51
placement, 55
plants, non-base, 51
selecting, 30, 51
spacing, 33, 36
Emission device, supplemental on
Landscape Dripline, 57
Emitter discharge rate, 44
Emitters. *See* Emission devices
Evaporation, 13
Evapotranspiration, potential, 13, 21

—F—

Factor
density, 22
microclimate, 23
plant, 22
species, 22
Field capacity, 12
Filter, 10, 32
Filtration, 10, 32
Flow, 64
maximum, 67, 69
Flow rate, 32, 51
emission device, 37
Friction loss, 63

—G—

Gravitational water, 12
Ground cover, 21

—H—

Hanging plants, irrigating, 62
Hot dry climate, 14
Hot humid climate, 14
Hydraulics, 63
Hydrozone, 14
dense, water requirements, 21
sparse, base plant, 29
Hygroscopic water, 12

—I—

Individual plants, 7
system run time, 45
water requirement, 24
Infiltration rate, maximum, 13
Inlet, 32
Inline tubing. *See* Landscape Dripline
Installation, 73
Installation details, 103
Installation cost, 4, 31
Intended use, 30
Interval, irrigation, 48
Irrigating
base plants, 29
large areas, 30
slopes, 61
Irrigation
conventional. *See* Conventional irrigation
low-volume. *See* Low-volume irrigation
Irrigation design, 6
Irrigation interval, 48
Irrigation method, 15

—K—

K_c , 21, 24
calculating, 21, 24

—L—

Landscape Dripline, 32, 57
choices and models, 34
grid system, 33
lateral spacing, 35
slopes, installation on, 61
staking and stapling, 59
supplemental emission devices, 57
system configuration, 60
Landscape irrigation design, 6
Large areas, irrigating, 30
Lateral pipe, pressure loss, 70
Layout, 55
Length, tubing, 68
Low-volume irrigation, 1, 14
benefits, 2
design, 5
selecting, 4

—M—

Maintenance, 74
Maximum emission device spacing, 37
Maximum infiltration rate, 13
Maximum lateral lengths, 68
Maximum system run time, 46
Maximum wetted diameter, 13
Maximum wetting patterns, 13
Mesh, 10
Meter, water, 10
Microclimate, 23
Microclimate factor, 23
Micro-sprays, 32, 43
Minimum area to be wetted, 40
Minimum desired watering depth, 36
Minimum watering depth, 36
Multi-outlet Shrub Xeri-Bug, 32, 52
Multi-outlet Xeri-Bug, 32, 52

—N—

Non-base plants, irrigating, 51

—O—

Outlet, 32

—P—

Permanent wilting point, 12
PET, 13, 21, 81
Plant
 base, dense hydrozone, 21
 canopy, 25
 diameter, 24
 dominant, 21
 factor, 21
 species, 22
 water requirement, 19
Planting scheme, 21
Plants
 dense, 7
 selecting emission devices, 32
 water requirement, 24
 individual, 7
 water requirement, 24
 sparse, 7
 selecting emission devices, 37
 water requirement, 24
Plants, non-base
 irrigating, 51
Potential evapotranspiration, 13, 21, 81
Pressure
 dynamic, 63
 loss, 63, 85
 lateral pipe, 70
 valve, 70
 static, 10, 63
 water, 63
Pressure Compensating Modules, 32, 52
Pressure compensation, 32
Products, Xerigation, 32, 99

—R—

Rain Bird, Technical support, 4
Rate
 emission device flow, 37
 emitter discharge, 44
Reference PET, 13, 81
Root depth, 36
Root zone, 2, 5
Run time
 calculating, 44
 system, 43
 system, maximum, 46

—S—

Safety, 4, 30
Sand, 11
Scheduling, 43
Screen, 10
Selecting emission devices
 dense plants, 32
 sparse plants, 37
Selecting low-volume irrigation, 4
Shrub Xeri-Bug Single
 Outlet Emitter, 32, 52
Silt, 11
Site data, 9, 17
Slopes, irrigating, 61
Soil
 coarse, 11
 fine, 11
 medium, 11
 type, 11
Source, water, 10
Spacing
 emission device, 36
 maximum, 37
Sparse Hydrozone Design Worksheet, 20
Sparse hydrozone, base plant, 29
Sparse plants, 7
 selecting emission devices, 30, 51
 system run time, 45
 water requirement, 24
Species
 factor, 22
 plant, 22
Stakes and staples, 59
Static pressure, 10, 63
Sub-climate. *See Microclimate*
Surface water, 10
System layout, 55, 60
System run time, 43
 calculating, 44
 maximum, 46

—T—

Technical support, 4
Time, system run, 43
Traffic, 30
Transpiration, 13
Trees, 23
Troubleshooting, 74

—V—

Valve, 14
 pressure loss through, 69
 zone, 14
Valve, DV, 69
Vandalism, 4, 30

—W—

Warm dry climate, 14
Warm humid climate, 14
Wasted water, 2, 15
Water
 available, 12
 capillary, 12
 dirty, 10
 gravitational, 12
 hygroscopic, 12
 meter, 10
 movement
 horizontal, 11
 vertical, 11
 pressure, 10, 63
 quality, 10
 requirement, 19
 calculating, 21
 dense plants, 24
 sparse plants, 24
 source, 10
Water requirement, 19, 21, 51
 dense hydrozone, 21
 dense plants, 24
 individual plants, 24
 sparse plants, 24
Watering
 depth, minimum desired, 36
 window, 30
Well water, 10
Wet/dry cycle, 3
Wetted diameter, maximum, 13
Wetting pattern, 13
 emission device, 52
 maximum, 13
Wilting point, permanent, 12
Window, watering, 30
Worksheet
 Dense Hydrozone Design, 20
 Site Data, 9
 Sparse Hydrozone Design, 20

—X—

Xeri-Bird-8, 32
Xeri-Bubblers, 32, 52
Xeri-Bug Single Outlet Emitter, 32, 52
Xeri-Pop Micro-Spray Pop-Ups, 32, 38
Xerigation, 1
 design, 6
 products, 32, 99
Xeriscape, 1
Xeri-Sprays, 32, 38



For Technical Assistance,
Call Toll Free
1-800-247-3782

An ancient Indian legend tells of a terrible drought that befell the land hundreds of years ago. Crops withered and the watering holes dried up. For a generation there was no relief. Everyone but the children gave up hope. Then, one day, a great bird overheard the children's simple, urgent prayers. The bird flew to the heavens and returned with the long-awaited, life-giving rain. The bird-like appearance of the efficient impact sprinkler, which the company founders introduced to the world in 1935, prompted them to name their new company after the great rain bird of Indian legend. And so the modern Rain Bird legend was born.

Since our dramatic entrance into the market more than 60 years ago, Rain Bird has grown into the largest manufacturer of irrigation systems in the world. Quality products. Water-saving solutions. Worldwide service and support. At every step, our focus has been to manage and conserve our planet's most valuable, natural resource—water. Rain Bird. Because every drop counts.



Rain Bird Corporation
970 West Sierra Madre Avenue, Azusa, CA 91702
Phone: (626) 963-9311 Fax: (626) 812-3411

Specification Hotline
1-800-458-3005 (U.S. only)

Rain Bird Technical Services
(800) 247-3782 (U.S. only)

www.rainbird.com

 Recycled Paper.

Rain Bird. Conserving More Than Water

® Registered Trademark of Rain Bird Sprinkler Mfg. Corp.
©2000 Rain Bird Sprinkler Mfg. Corp. 2/00
D39030D